

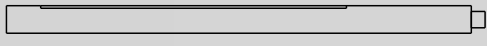





Vérifier que vous avez bien toutes les pièces avant d'effectuer le montage

Demande sav

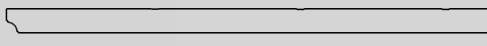
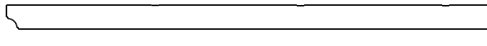
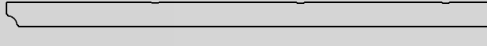
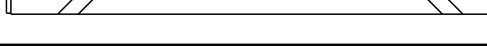
Réf.	Qté.	Dessin pièce	Dimensions (en mm)			Observation	Qté.
1	2		120	120	2090		
2	4		120	120	2125		
3	1		80	160	4039		
4	1		80	160	4039		
5	1		120	160	4039		
6	1		45	120	3383		
7	1		45	120	3383		
8	1		45	120	3383		
9	1		45	120	3383		
10	2		45	95	580		
11	2		45	95	703		
12	2		45	95	703		
13	4		45	95	837		
14	4		45	95	837		

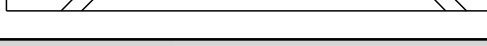
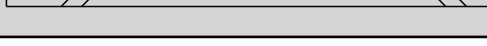
A compléter impérativement pour toute demande SAV et à envoyer par mail à [sav@foresta.fr](mailto:sav@foresta.fr) + photo des pièces abîmées

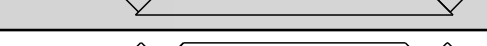
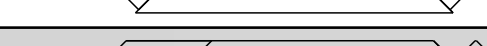
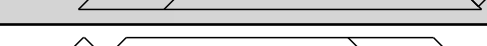
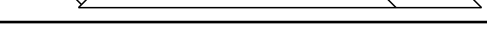
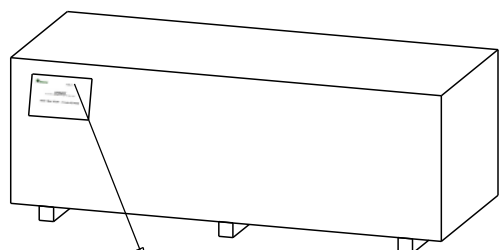

Colis n°: \_\_\_\_\_

**OM 3570.0**

Colis n°: \_\_\_\_\_

NOM DU MAGASIN  
(où l'auvent a été acheté)

NOM DU CLIENT

PRENOM DU CLIENT

N° de téléphone









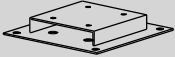
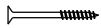

**NOTICE DE MONTAGE du Ombra**  
**Réf. OM 3570.0**

						Demande sav	
Réf.	Qté.	Dessin pièce	Dimensions (en mm)			Observation	Qté.
15	1		45	120	3798		
16	1		45	120	3800		
17	2		45	145	3838		
18	2		45	145	3844		
19	2		45	145	3848		
20	4		45	145	3852		
21	2		45	95	736		

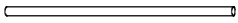
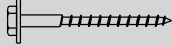

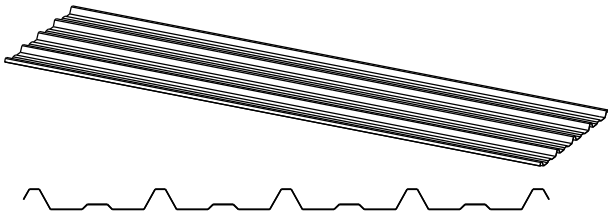



A compléter impérativement pour toute demande SAV et à envoyer par mail à [sav@foresta.fr](mailto:sav@foresta.fr) + photo des pièces abîmées

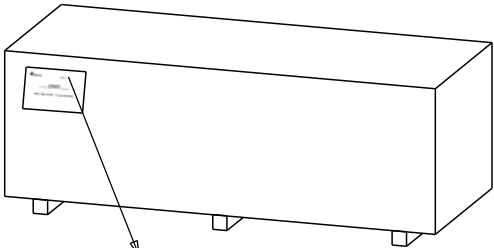





<p>Colis n°: _____</p>	<p><b>OM 3570.0</b></p> <p>Colis n°: _____</p>	NOM DU MAGASIN (où l'auvent a été acheté)	
		NOM DU CLIENT	
		PRENOM DU CLIENT	
		N° de téléphone	

						Demande sav	
Réf.	Qté.	Dessin pièce	Dimensions (en mm)			Observation	Qté.
q1	6		22	160	160		
q2	24			∅ 5	60		
q3	270			∅ 4	40		
q4	20			∅ 5	80		
q5	18		50	90	50		
q6	16			∅12	150		
q7	110			∅6,5	100		
q8	56			∅4,8	20		
q9	110		38	12	40		
q10	8		40	1000	3935		
q11	1						

A compléter impérativement pour toute demande SAV et à envoyer par mail à [sav@foresta.fr](mailto:sav@foresta.fr) + photo des pièces abîmées

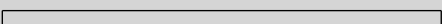
 <p>Colis n°: _____</p>	<p><b>OM 3570.0</b></p> <p>Colis n°: _____</p>	NOM DU MAGASIN (où l'auvent a été acheté)	
		NOM DU CLIENT	
		PRENOM DU CLIENT	
		N° de téléphone	

						Demande sav	
Réf.	Qté.	Dessin pièce	Dimensions (en mm)			Observation	Qté.
q12	14			70			
q13	4			70	2000		
q14	5			70			
q15	2			70			
q16	2			70			
q17	1						

						Demande sav	
Réf.	Qté.	Dessin pièce	Dimensions (en mm)			Observation	Qté.
d1	8		20	120	3500		
d2	2		20	120	3054		
d3	2		20	120	2904		
d4	2		20	120	1135		
d5	2		20	120	985		
d6	4		20	120	580		

A compléter impérativement pour toute demande SAV et à envoyer par mail à  
sav@foresta.fr + photo des pièces abîmées

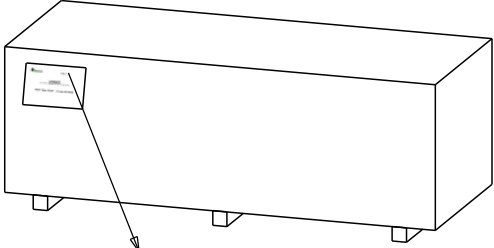
 <p>Colis n°: _____</p>	<p><b>OM 3570.0</b></p> <p>Colis n°: _____</p>	NOM DU MAGASIN (où l'auvent a été acheté)	
		NOM DU CLIENT	
		PRENOM DU CLIENT	
		N° de téléphone	

Plan de soubassement

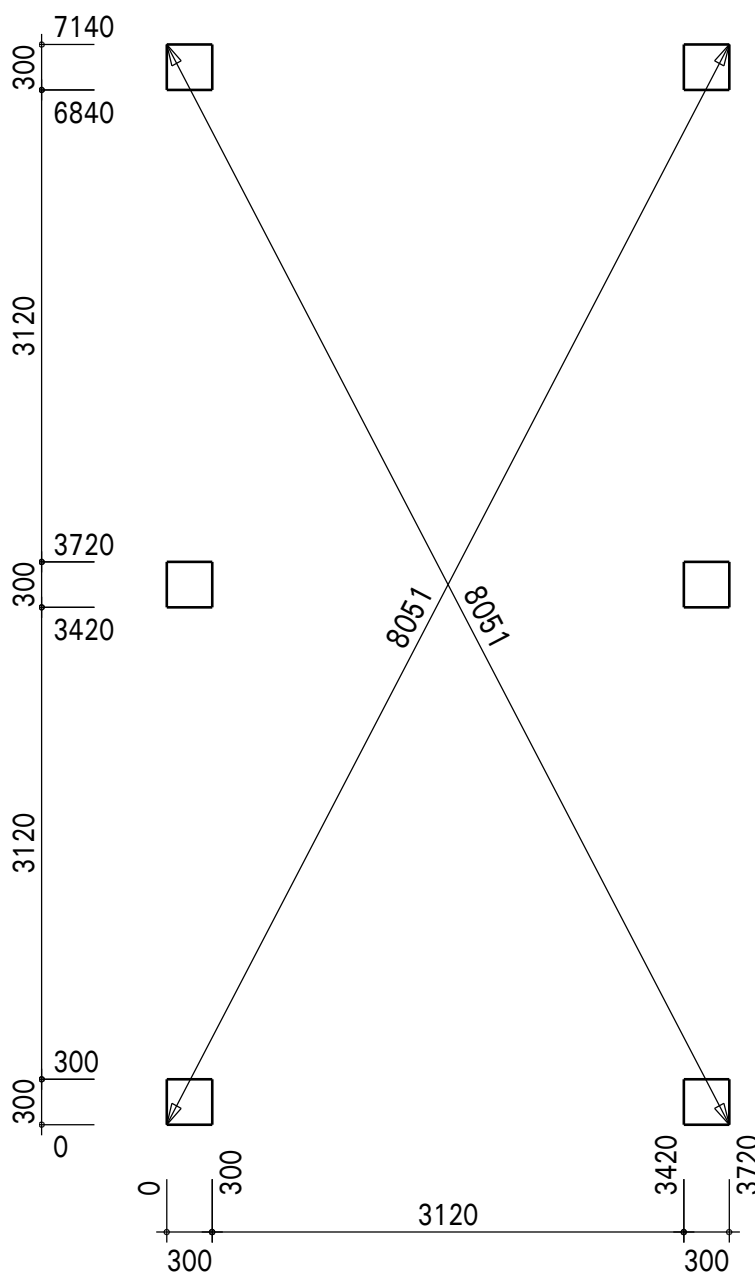

Les dimensions données sur le plan de soubassement sont les dimensions de la dalle béton à réaliser sur un sol parfaitement plat sans aucun autre objet extérieur type mur, clôture ou arbre dans l'entourage de la dalle. Si le produit est implanté près d'un mur, d'une haie ou d'un arbre il est nécessaire de l'éloigner des éléments extérieurs afin de pouvoir facilement le monter et l'entretenir. Nous nous dégageons de toute responsabilité en cas de mauvaise interprétation des dimensions de la dalle.

Le dimensioni del piano di base sono le dimensioni della soletta di cemento da realizzare su un terreno perfettamente piatto, senza alcun altro oggetto esterno, come un muro, una recinzione o un albero in prossimità della soletta. Se il prodotto è installato vicino ad una parete, un recinto o un albero, è necessario distanziarlo adeguatamente, in modo da poterlo facilmente montare e farne la manutenzione. Non ci assumiamo alcuna responsabilità per l'errata interpretazione delle dimensioni della lastra.

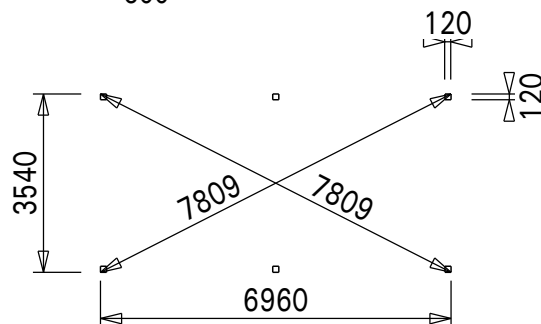

Tolérances à respecter (selon DTU 31.2):

- longueur et largeur:  $\pm 0,01\text{m}$ ;
- équerrage:  $\pm 0,01\text{m}$  mesuré sur 10m;
- arase:  $\pm 0,01\text{m}$  sur une longueur de 10 mètres linéaires alignés ou non et de  $\pm 2\text{mm}$  par mètre linéaire;
- rectitude de bords en plan:  $\pm 5\text{mm}$ .

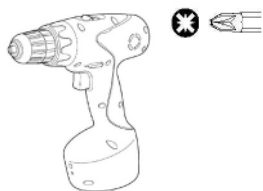
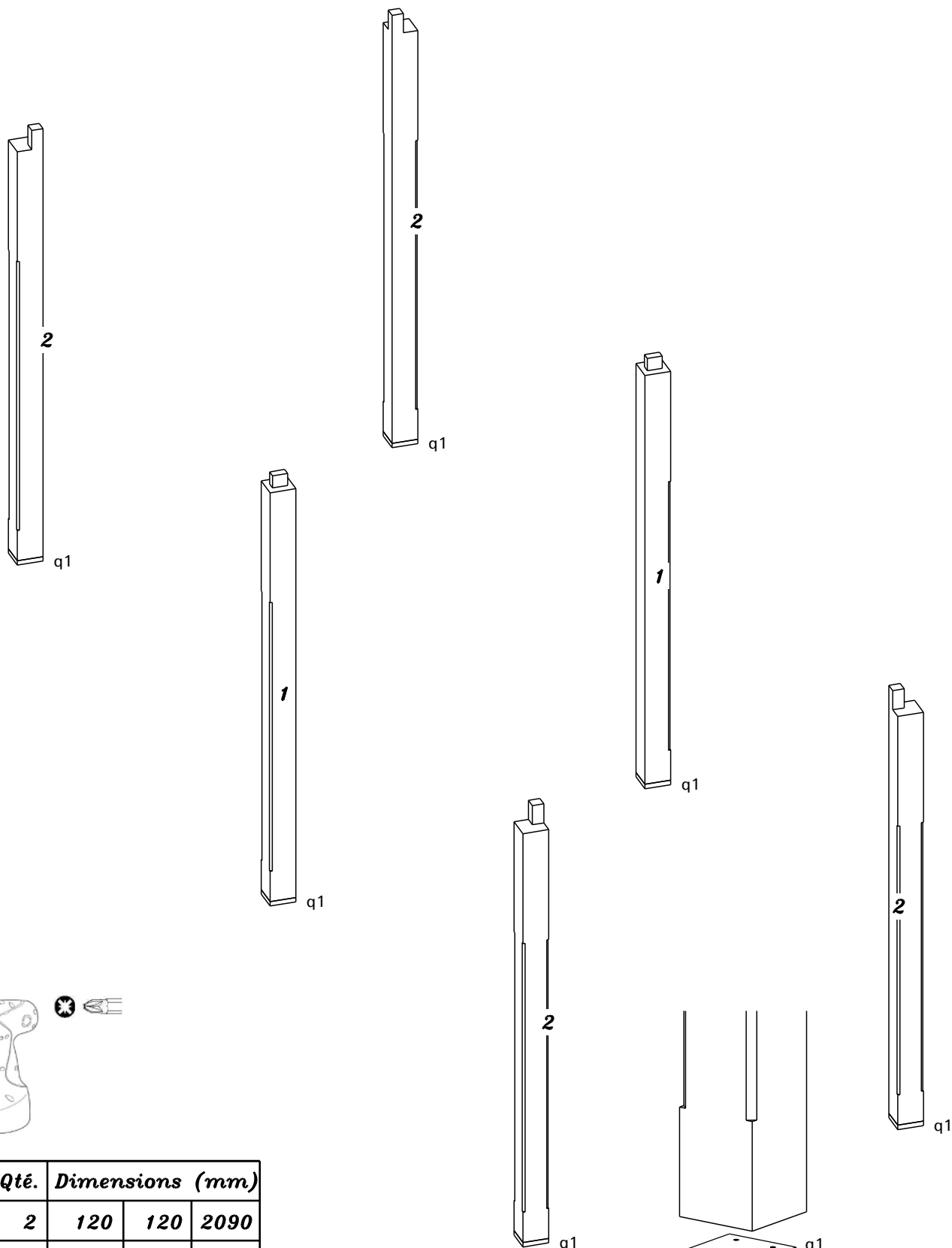

Réf.	Qté.	Dimensions (mm)		
1	2	120	120	2090
2	4	120	120	2125
q1	6	22	160	160
q2	24		∅ 5	60

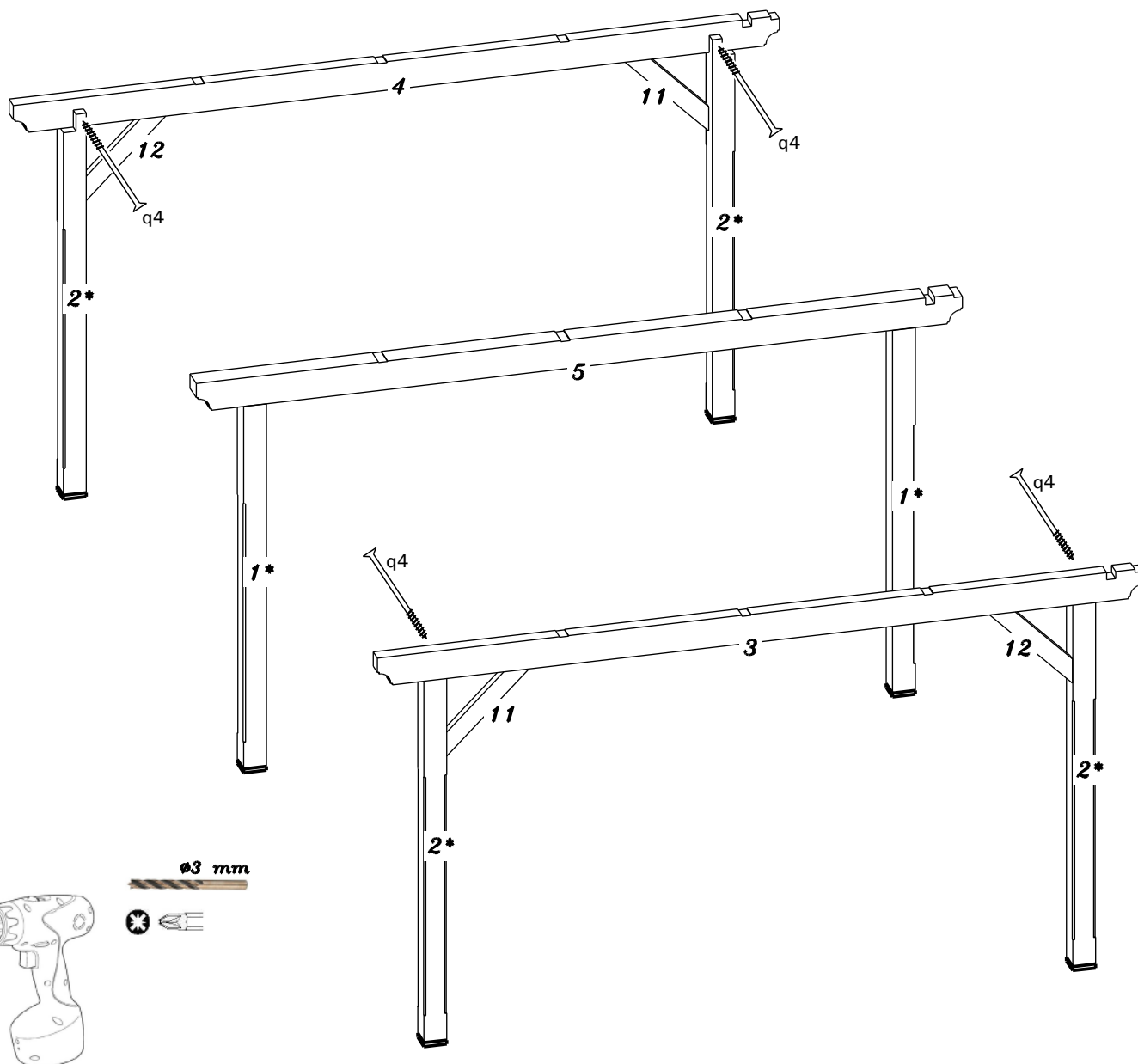

Réf.	Qté.	Dimensions (mm)		
3	1	80	160	4039
4	1	80	160	4039
5	1	120	160	4039
11	2	95	45	703
12	2	95	45	703

Réf.	Qté.	Dimensions (mm)		
q4	4		∅ 5	80



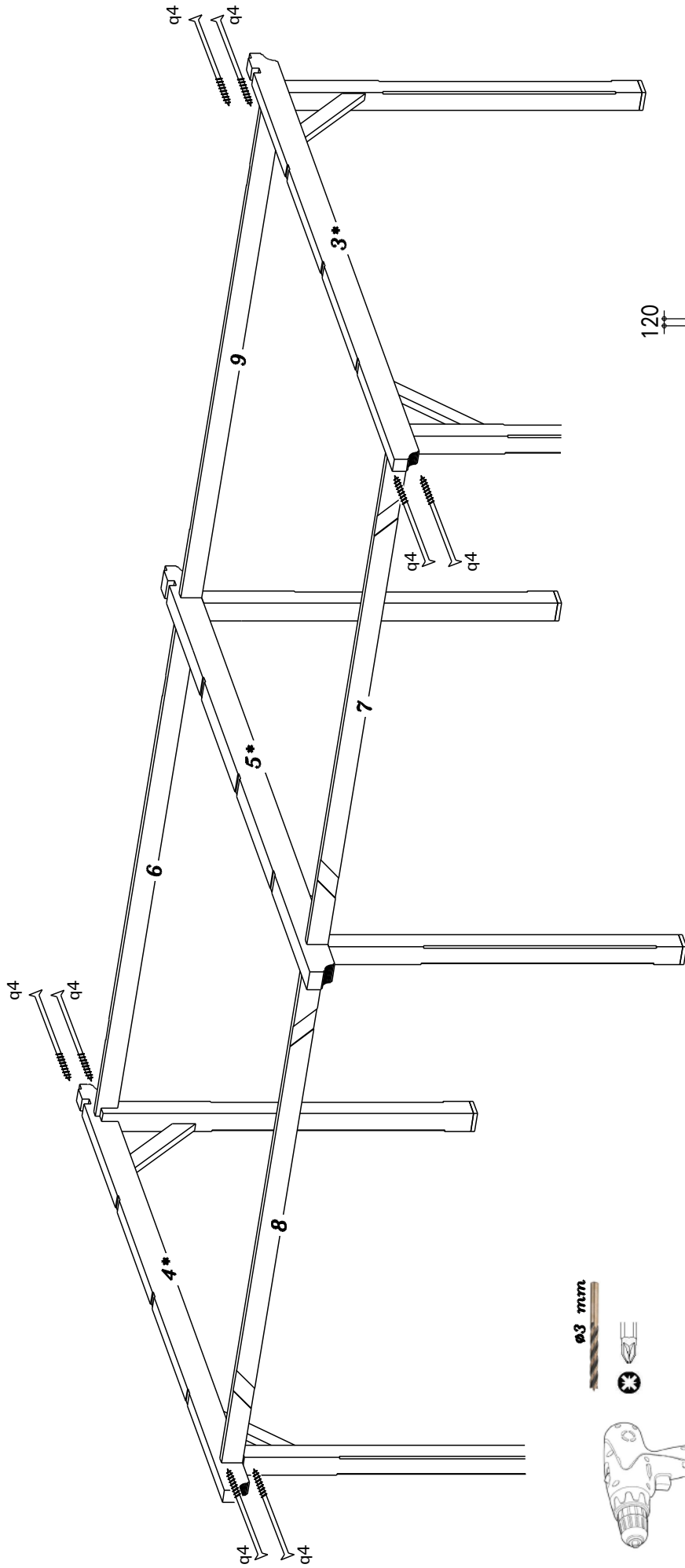

$\phi 3$  mm



Réf.	Qté.	Dimensions (mm)
6	1	45 120 3383
7	1	45 120 3383
8	1	45 120 3383
9	1	45 120 3383

Réf.	Qté.	Dimensions (mm)
q4	8	$\phi 5$ 80

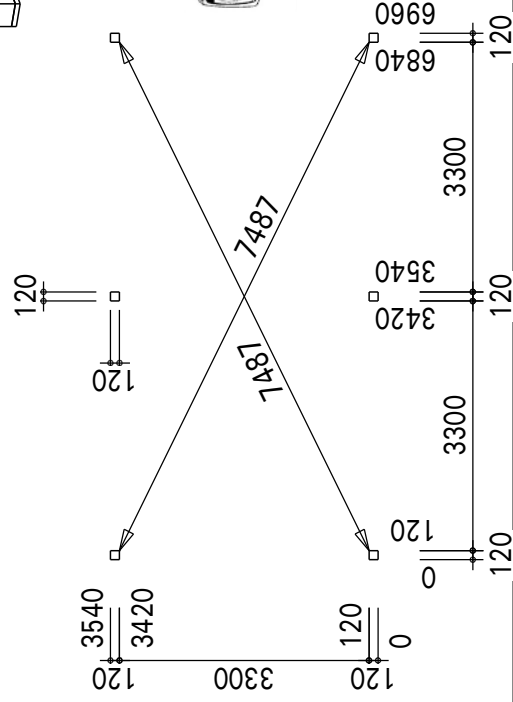

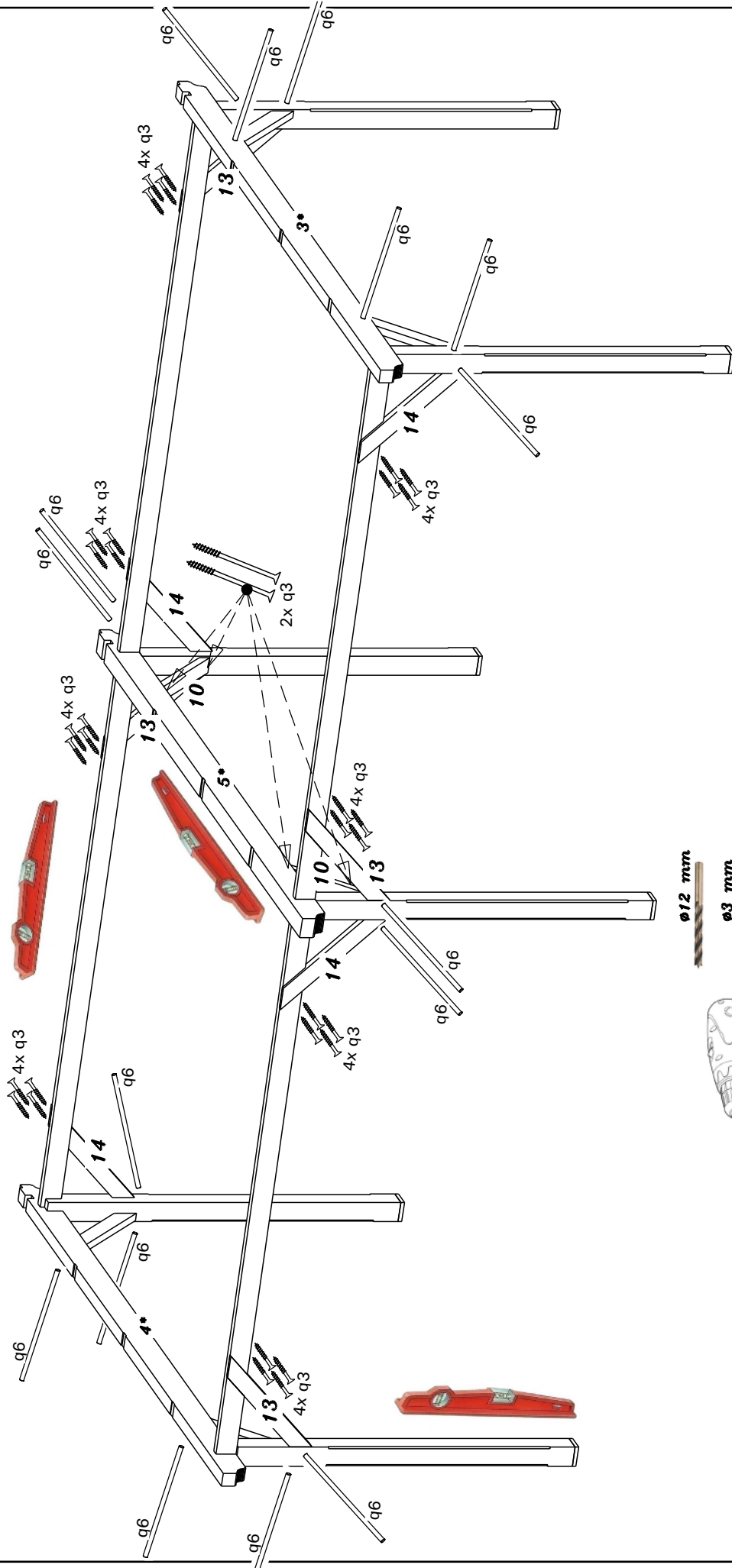

Réf.	Qté.	Dimensions (mm)	
10	2	95	45 580
13	4	95	45 837
14	4	95	45 837

Réf.	Qté.	Dimensions (mm)	
q3	32	ø 4	40
q6	16	ø12	150

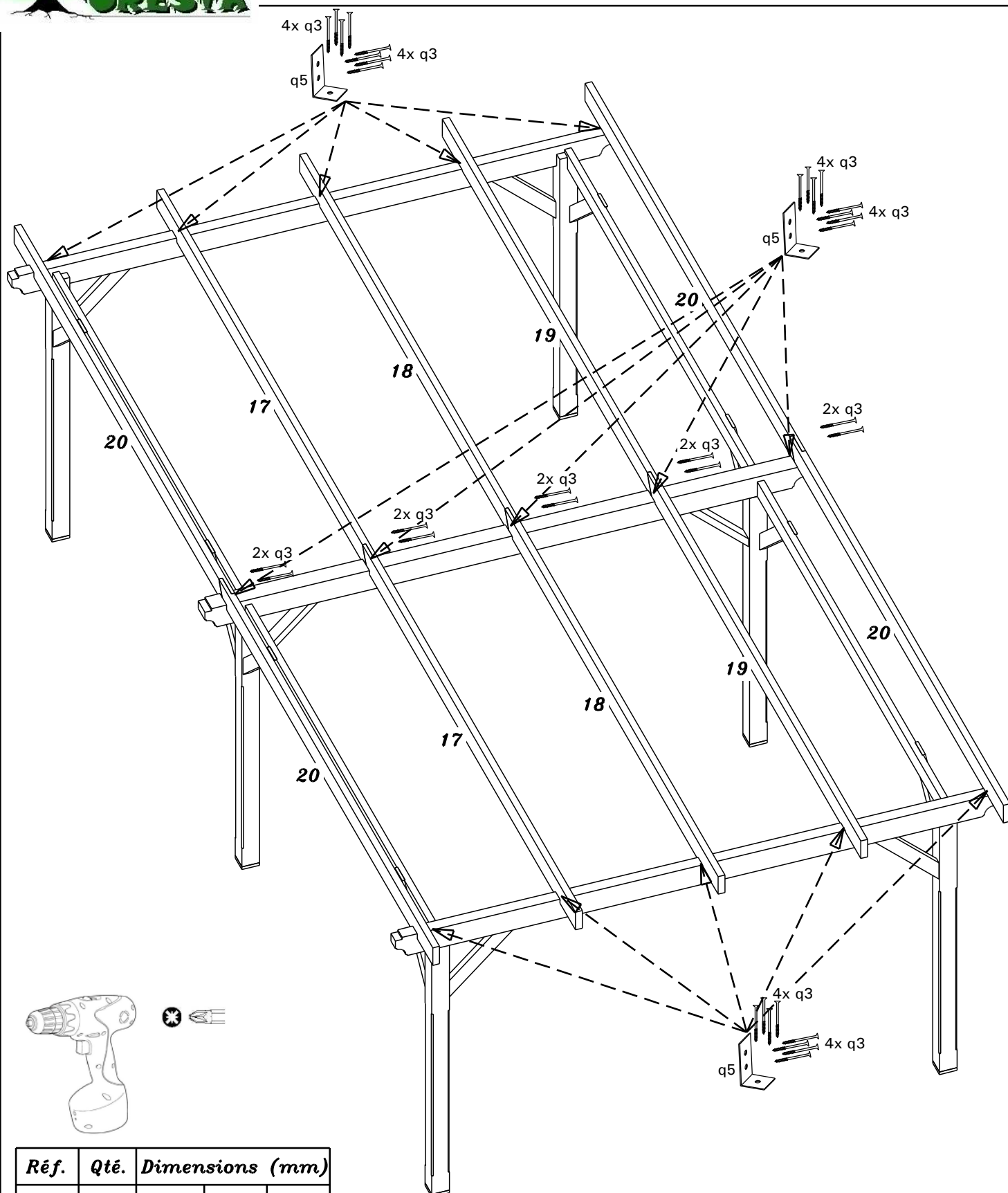

Réf.	Qté.	Dimensions (mm)		
17	2	45	145	3838
18	2	45	145	3838
19	2	45	145	3838
20	4	45	145	3838

Réf.	Qté.	Dimensions (mm)		
q3	130		∅ 4	40
q5	15	50	90	50

Pour la pose de gouttière pensez aux différences de niveau des crochets afin d'obtenir une pente moyenne de 5 mm par mètre dans le sens de l'écoulement des eaux.

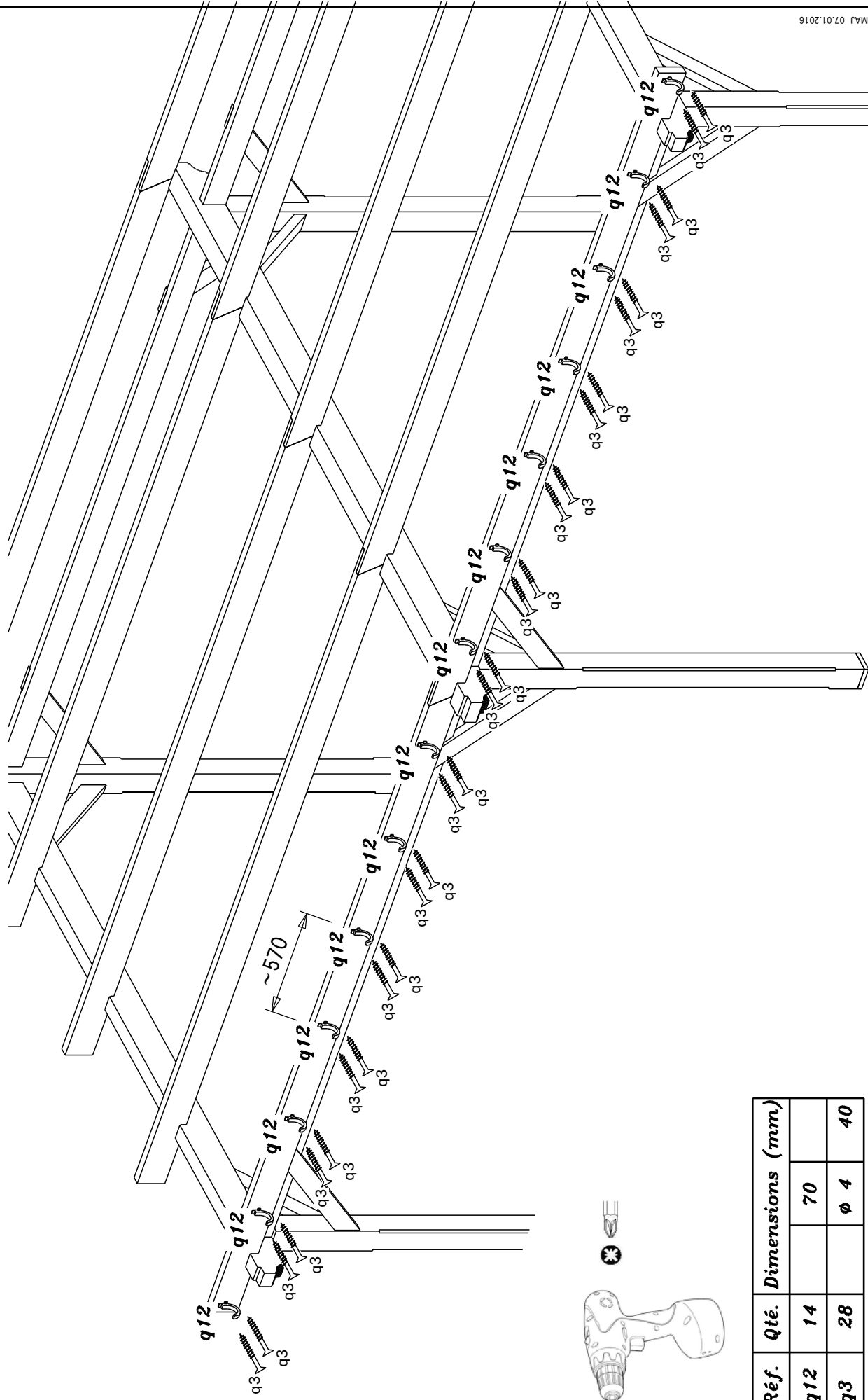

Réf.	Qté.	Dimensions (mm)	
q12	14		70
q3	28	∅ 4	40

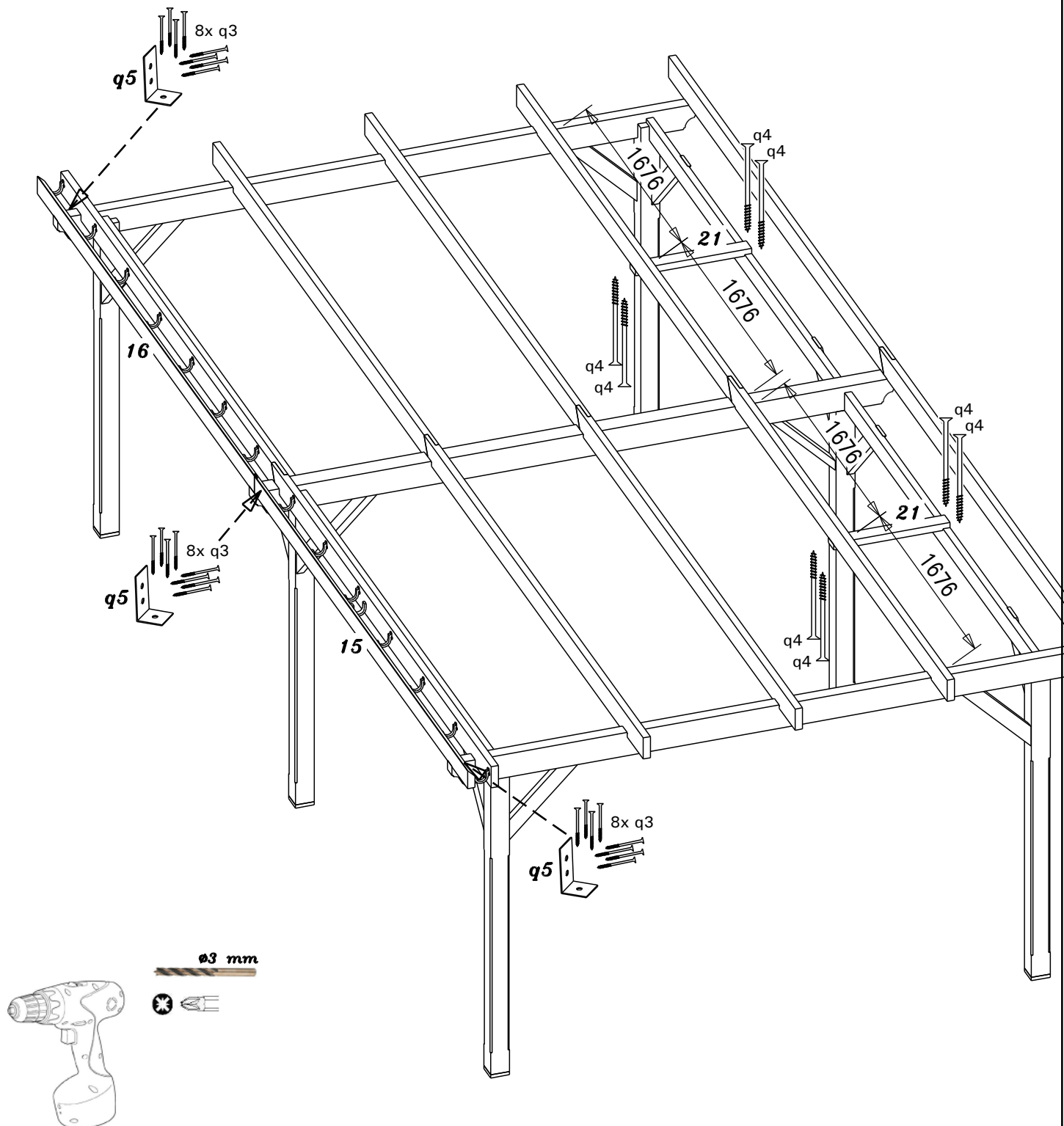

Réf.	Qté.	Dimensions (mm)		
15	1	45	120	3798
16	1	45	120	3800
21	2	45	95	736

Réf.	Qté.	Dimensions (mm)		
q3	24	∅ 4		40
q4	8	∅ 5		80
q5	3	50	90	50

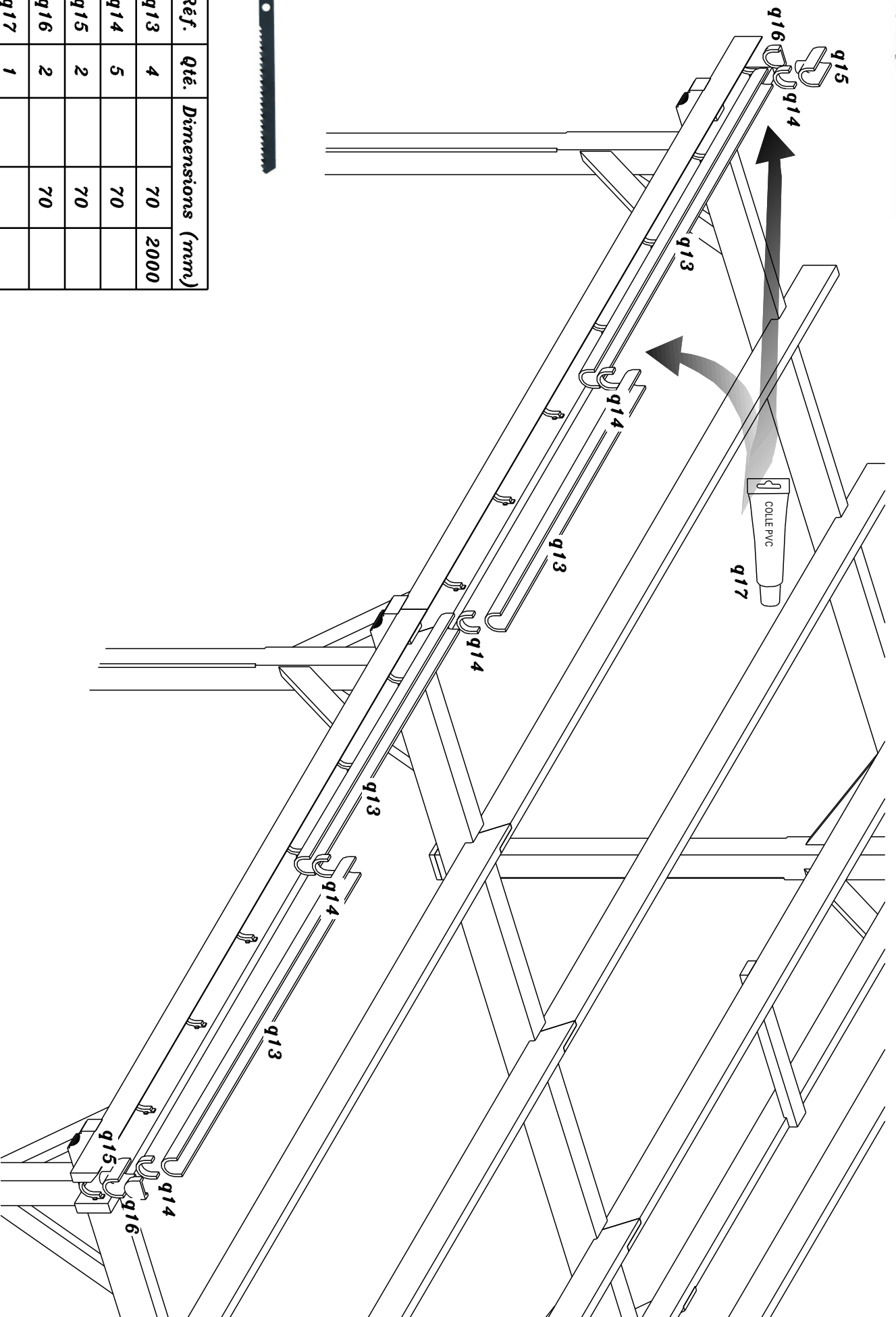

Réf.	Qté.	Dimensions (mm)	
q13	4	70	2000
q14	5	70	
q15	2	70	
q16	2	70	
q17	1		



**NOTICE DE MONTAGE du Ombra**  
**Réf. OM 3570.0**

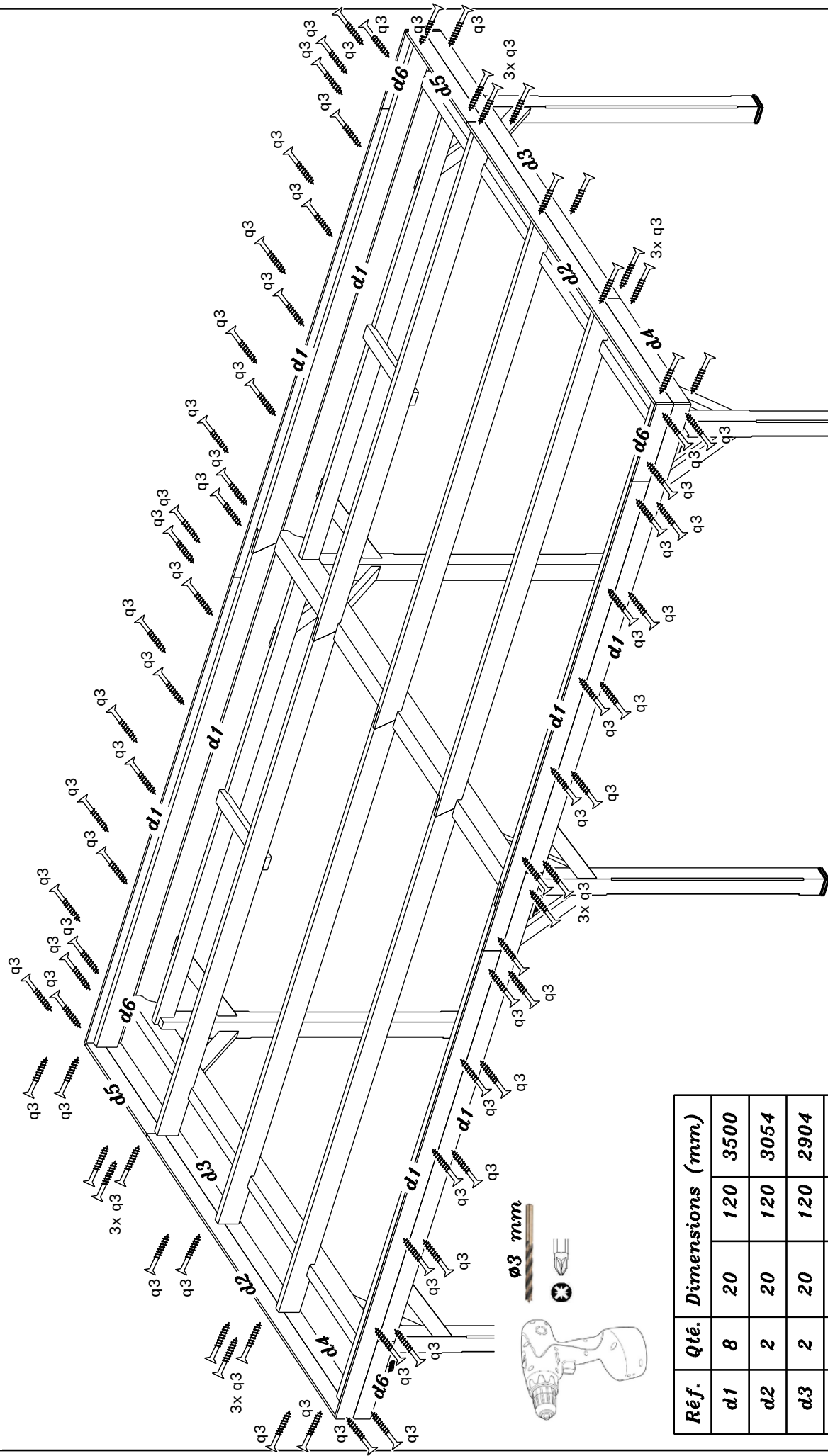

Réf.	Qté.	Dimensions (mm)
d1	8	20 3500
d2	2	20 3054
d3	2	20 2904
d4	2	20 1135
d5	2	20 985
d6	4	20 120 580

Réf.	Qté.	Dimensions (mm)
q3	56	∅ 4 40

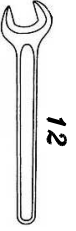
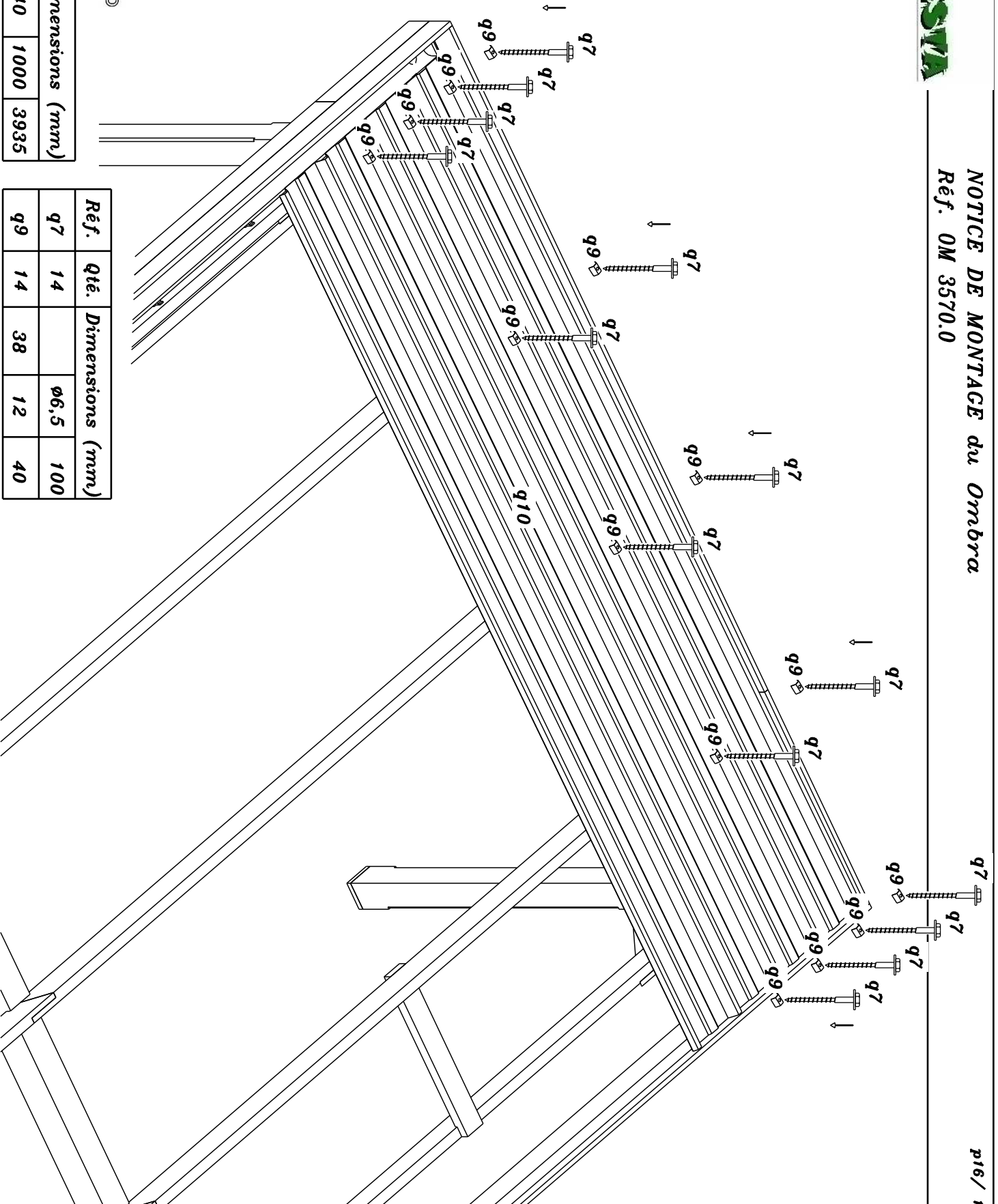

Réf.	Qté.	Dimensions (mm)		
q10	1	40	1000	3935

Réf.	Qté.	Dimensions (mm)		
q7	14		Ø6,5	100
q9	14	38	12	40



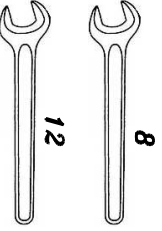
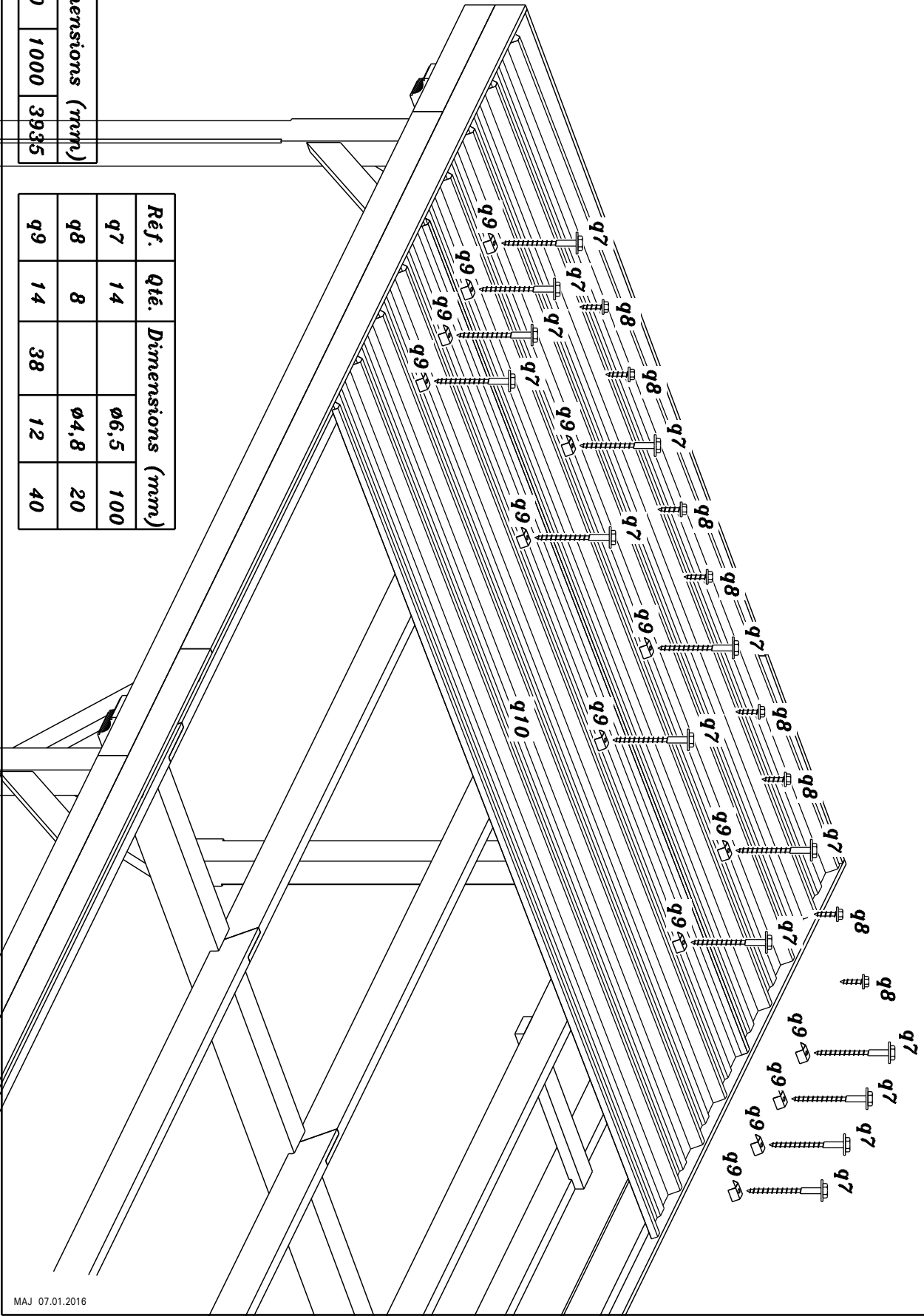

Réf.	Qté.	Dimensions (mm)		
q10	1	40	1000	3935

Réf.	Qté.	Dimensions (mm)		
q7	14		ø6,5	100
q8	8		ø4,8	20
q9	14	38	12	40



**NOTICE DE MONTAGE du Ombra**  
**Réf. OM 3570.0**

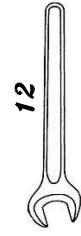
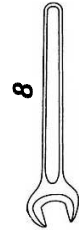
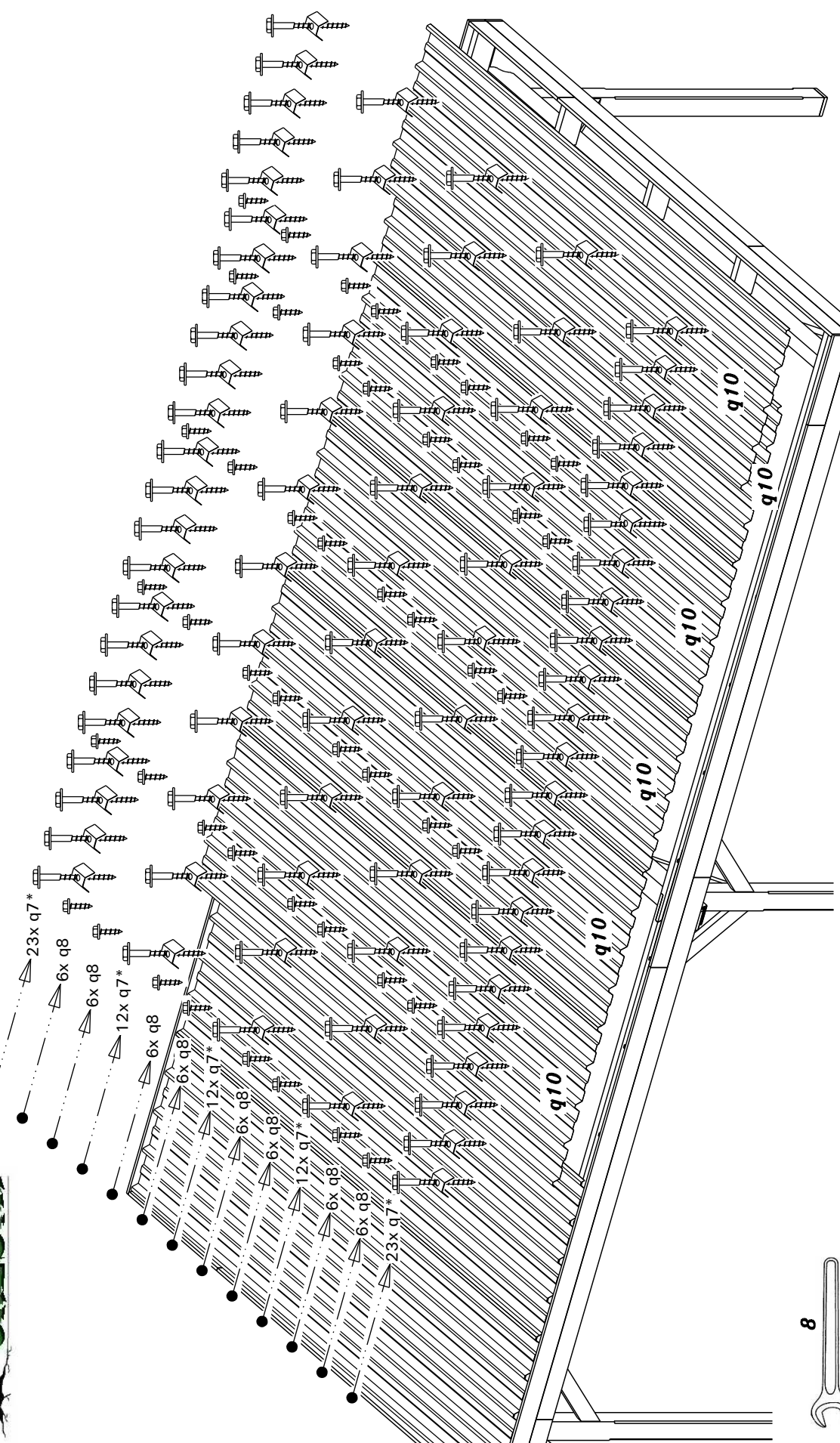

Réf.	Qté.	Dimensions (mm)	
q10	6	40	3935

Réf.	Qté.	Dimensions (mm)		
q7	82	Ø6,5	100	
q8	48	Ø4,8	20	
q9	82	38	12	40

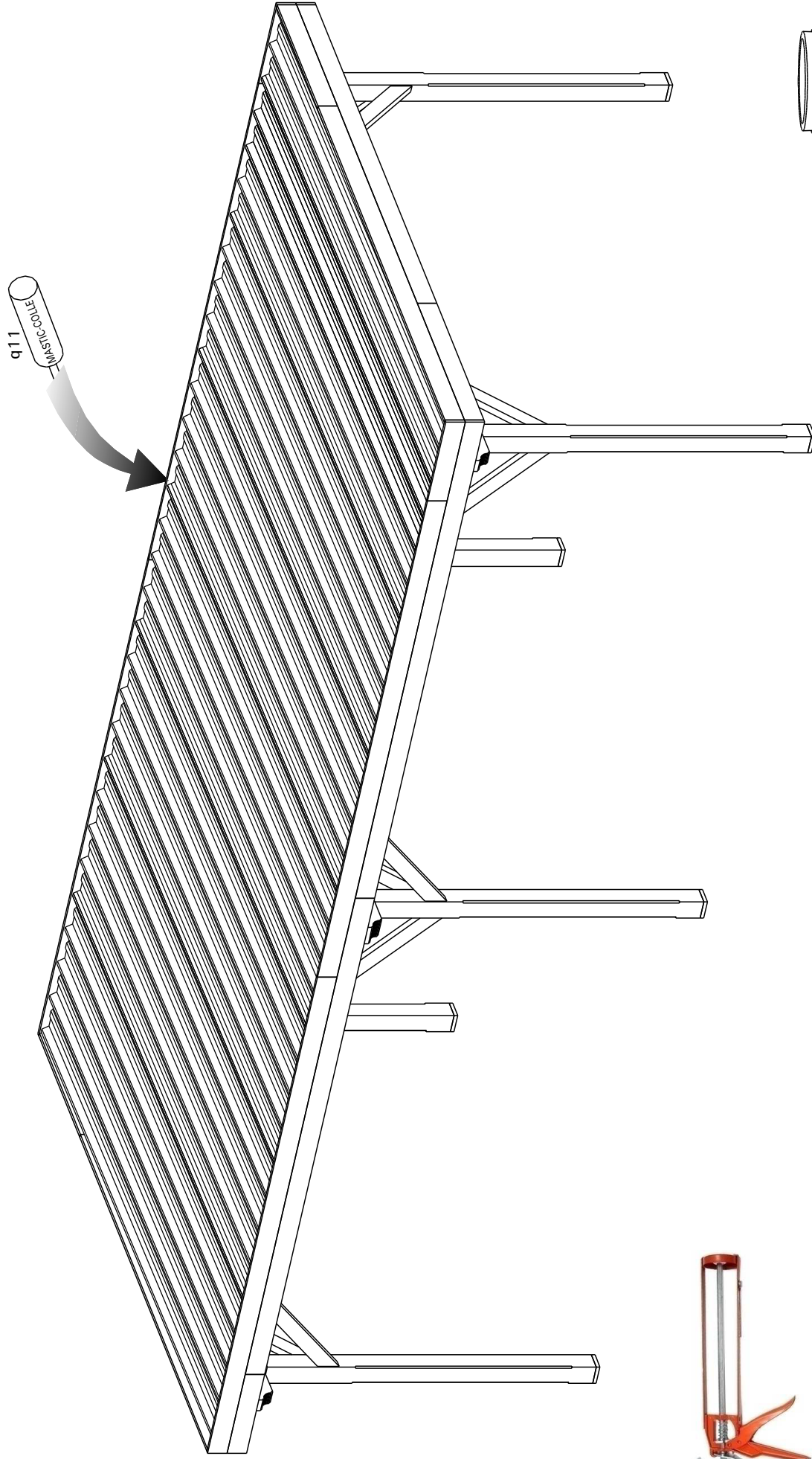

Réf.	Qté.	Dimensions (mm)
q11	1	

Penser à prévenir votre assureur de l'existence de votre auvent pour garantie en cas de sinistre.