

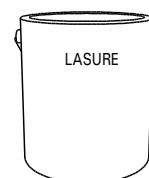

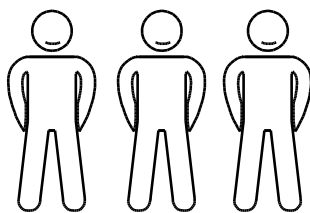

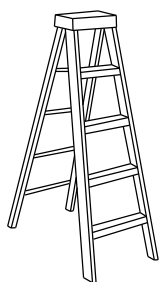

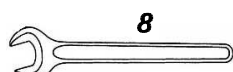

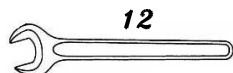

Ø3 mm

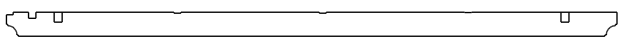
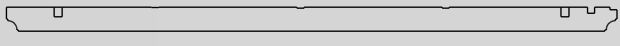
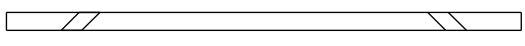
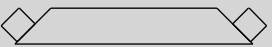
Ø12 mm

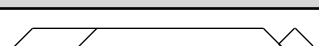

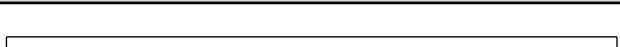
Vérifier que vous avez bien toutes les pièces avant d'effectuer le montage

Demande sav

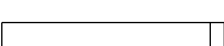
Réf.	Qté.	Dessin pièce	Dimensions (en mm)			Observation	Qté.
1	4		120	120	2125		
2	1		80	160	4039		
3	1		80	160	4039		
4	2		45	120	3406		
5	2		45	95	703		
6	2		45	95	703		
7	2		45	95	836		
8	2		45	95	836		
9	1		45	120	4038		
10	1		45	145	4038		
11	1		45	145	4038		
12	2		45	145	4038		
13	1		45	145	4038		
14	1		45	95	736		

A compléter impérativement pour toute demande SAV et à envoyer par mail à sav@foresta.fr + photo des pièces abîmées

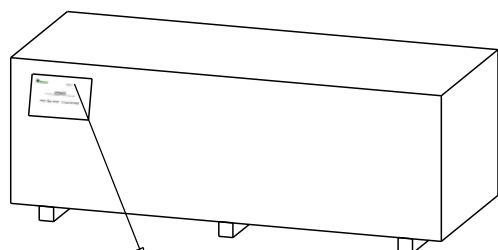

Colis n°: _____

OM 3535.0









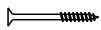

Colis n°: _____

NOM DU MAGASIN
(où l'auvent a été acheté)

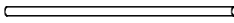
NOM DU CLIENT



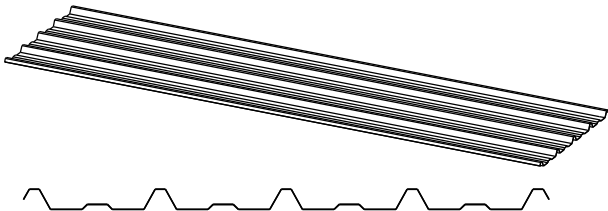



PRENOM DU CLIENT

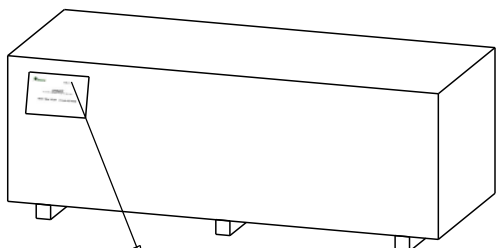





N° de téléphone

						Demande sav	
Réf.	Qté.	Dessin pièce	Dimensions (en mm)			Observation	Qté.
q1	4		22	160	160		
q2	16			∅ 5	60		
q3	184			∅ 4	40		
q4	16			∅ 5	80		
q5	12		50	90	50		
q6	12			∅12	150		
q7	61			∅6,5	100		
q8	24			∅4,8	20		
q9	61		38	12	40		
q10	4		40	1000	3935		
q11	1						

A compléter impérativement pour toute demande SAV et à envoyer par mail à sav@foresta.fr + photo des pièces abîmées

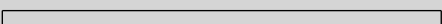
 Colis n°: _____	OM 3535.0 Colis n°: _____	NOM DU MAGASIN (où l'auvent a été acheté)	
		NOM DU CLIENT	
		PRENOM DU CLIENT	
		N° de téléphone	

						Demande sav	
Réf.	Qté.	Dessin pièce	Dimensions (en mm)			Observation	Qté.
q12	8			70			
q13	2			70	2000		
q14	2			70			
q15	1			70			
q16	2			70			
q17	1						

						Demande sav	
Réf.	Qté.	Dessin pièce	Dimensions (en mm)			Observation	Qté.
d1	4		20	120	3500		
d2	2		20	120	3054		
d3	2		20	120	2904		
d4	2		20	120	1135		
d5	2		20	120	985		
d6	4		20	120	610		

A compléter impérativement pour toute demande SAV et à envoyer par mail à sav@foresta.fr + photo des pièces abîmées

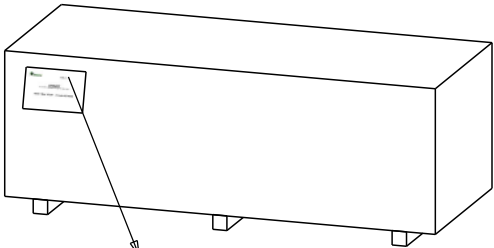
 <p>Colis n°: _____</p>	<p>OM 3535.0</p> <p>Colis n°: _____</p>	NOM DU MAGASIN (où l'auvent a été acheté)	
		NOM DU CLIENT	
		PRENOM DU CLIENT	
		N° de téléphone	

Plan de soubassement

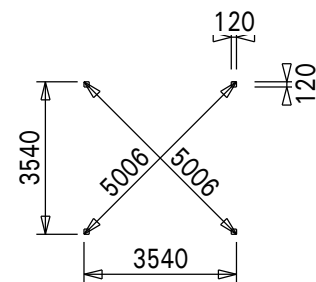
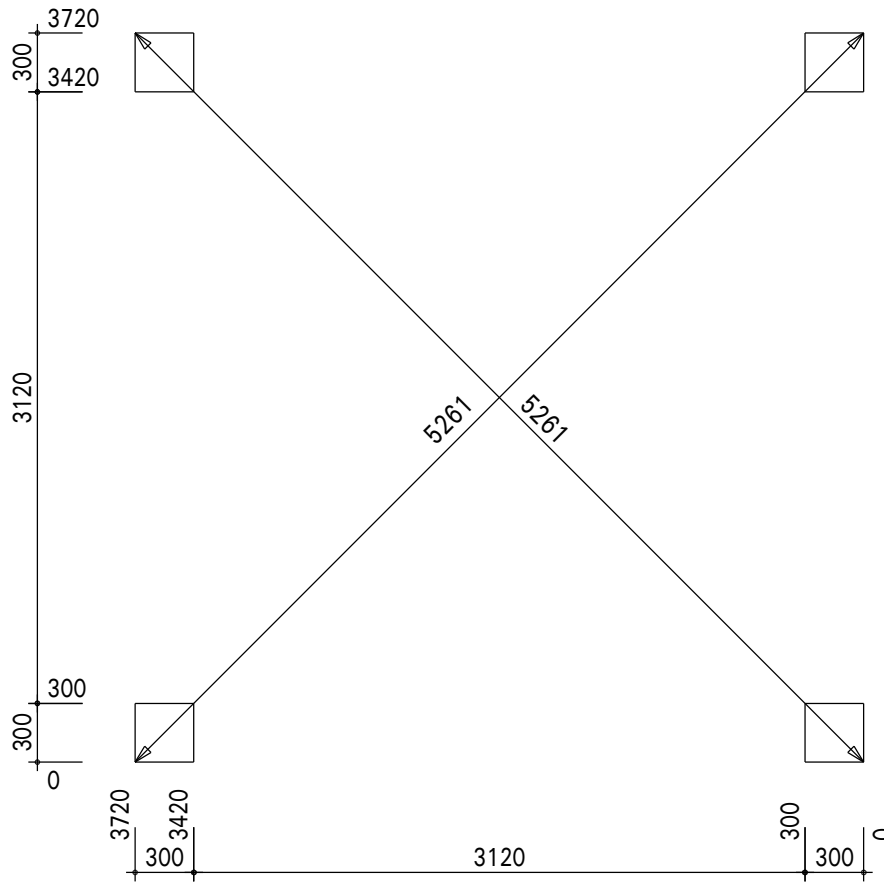

Tolérances à respecter (selon DTU 31.2):

- longueur et largeur: $\pm 0,01\text{m}$;
- équerage: $\pm 0,01\text{m}$ mesuré sur 10m;
- arase: $\pm 0,01\text{m}$ sur une longueur de 10 mètres linéaires alignés ou non et de $\pm 2\text{mm}$ par mètre linéaire;
- rectitude de bords en plan: $\pm 5\text{mm}$.

Les dimensions données sur le plan de soubassement sont les dimensions de la dalle béton à réaliser sur un sol parfaitement plat sans aucun autre objet extérieur type mur, clôture ou arbre dans l'entourage de la dalle. Si le produit est implanté près d'un mur, d'une haie ou d'un arbre il est nécessaire de l'éloigner des éléments extérieurs afin de pouvoir facilement le monter et l'entretenir. Nous nous dégageons de toute responsabilité en cas de mauvaise interprétation des dimensions de la dalle.

Le dimensioni del piano di base sono le dimensioni della soletta di cemento da realizzare su un terreno perfettamente piatto, senza alcun altro oggetto esterno, come un muro, una recinzione o un albero in prossimità della soletta. Se il prodotto è installato vicino ad una parete, un recinto o un albero, è necessario distanziarlo adeguatamente, in modo da poterlo facilmente montare e farne la manutenzione. Non ci assumiamo alcuna responsabilità per l'errata interpretazione delle dimensioni della lastra.

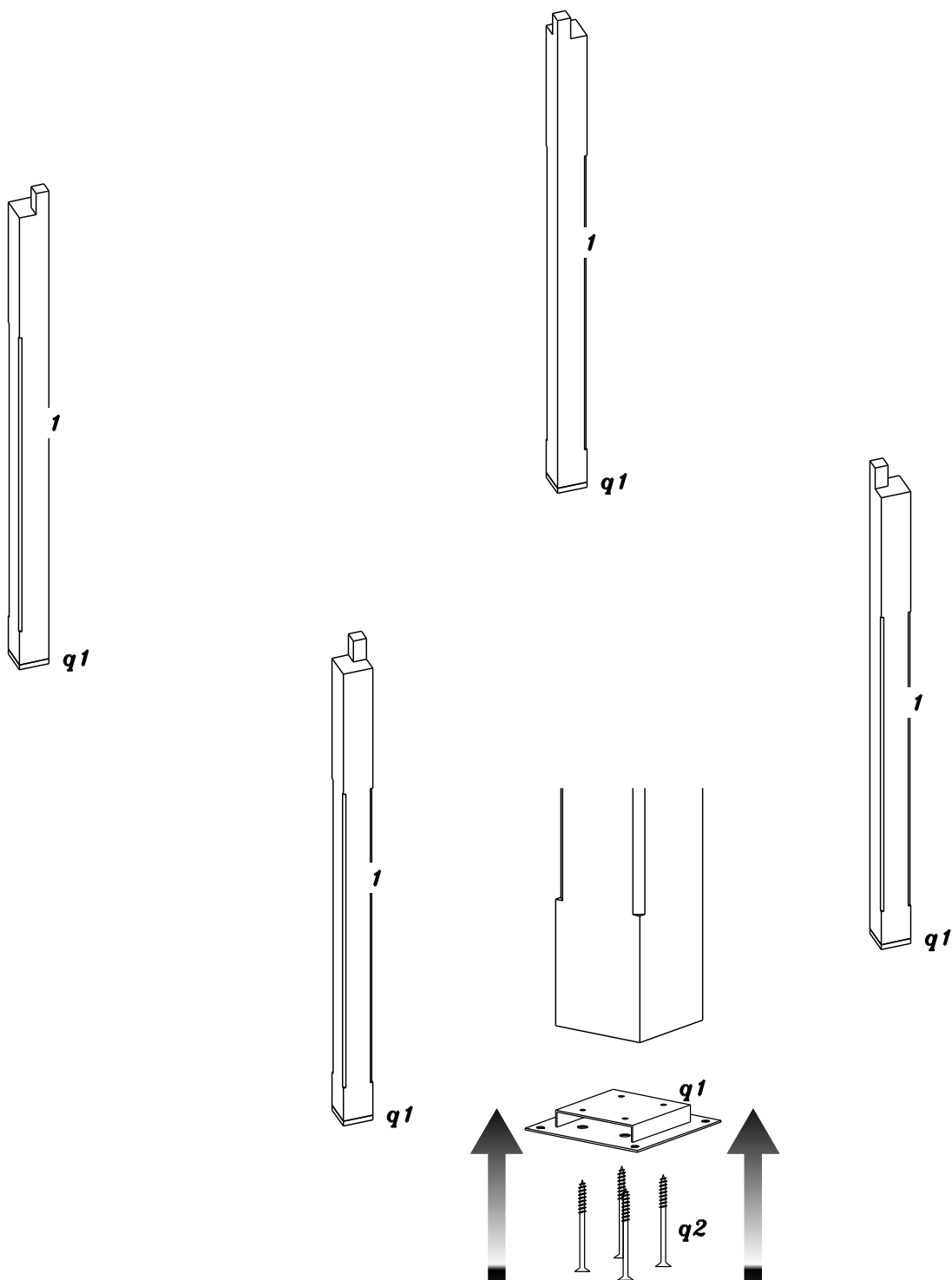

Réf.	Qté.	Dimensions (mm)		
1	4	120	120	2125
q1	4	22	160	160
q2	16		∅ 5	60

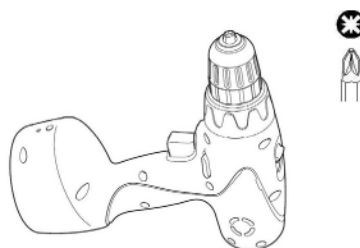

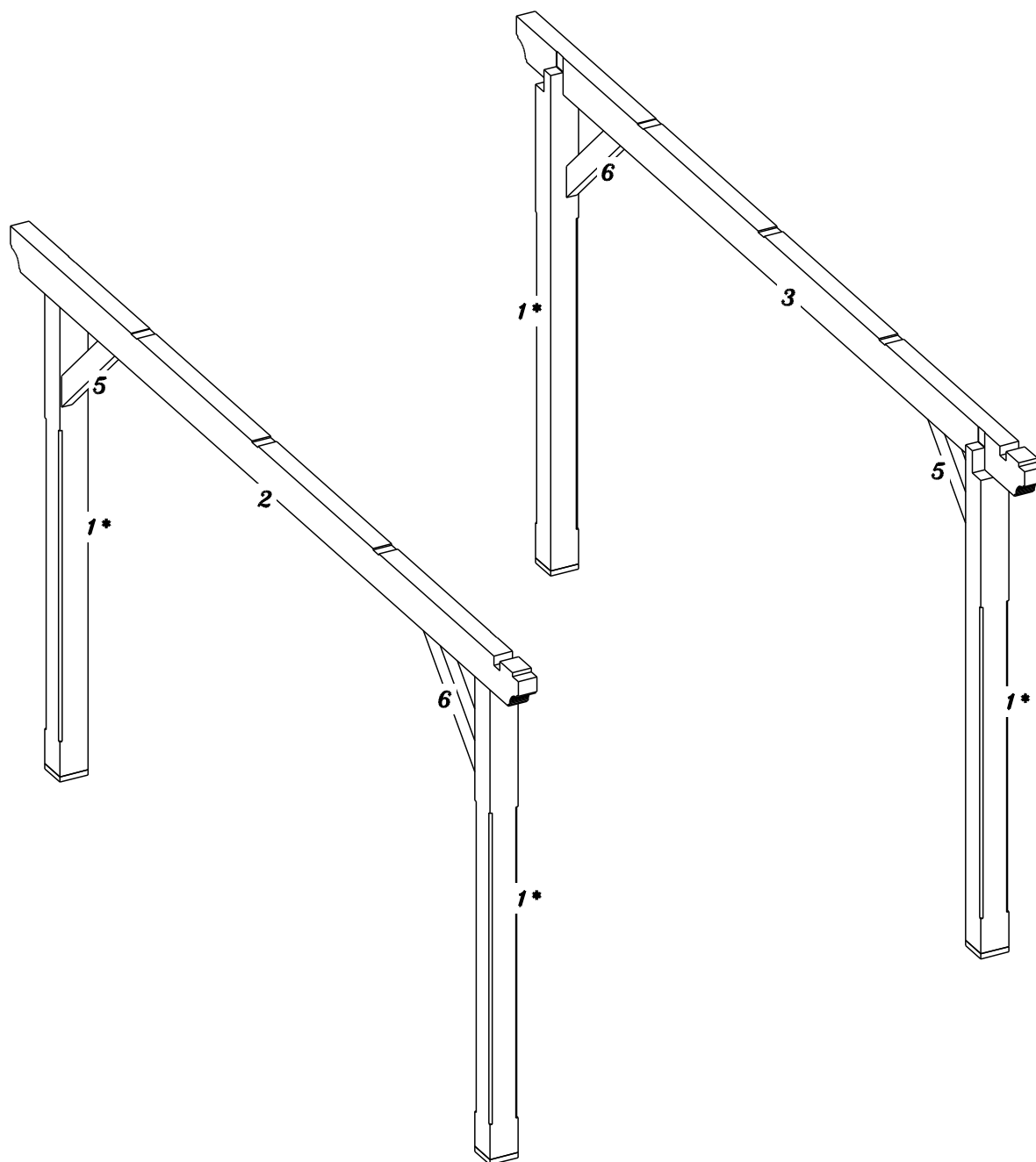

Réf.	Qté.	Dimensions (mm)		
2	1	80	160	4039
3	1	80	160	4039
5	2	95	45	703
6	2	95	45	703

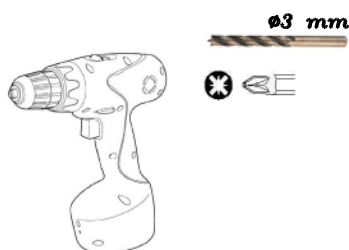
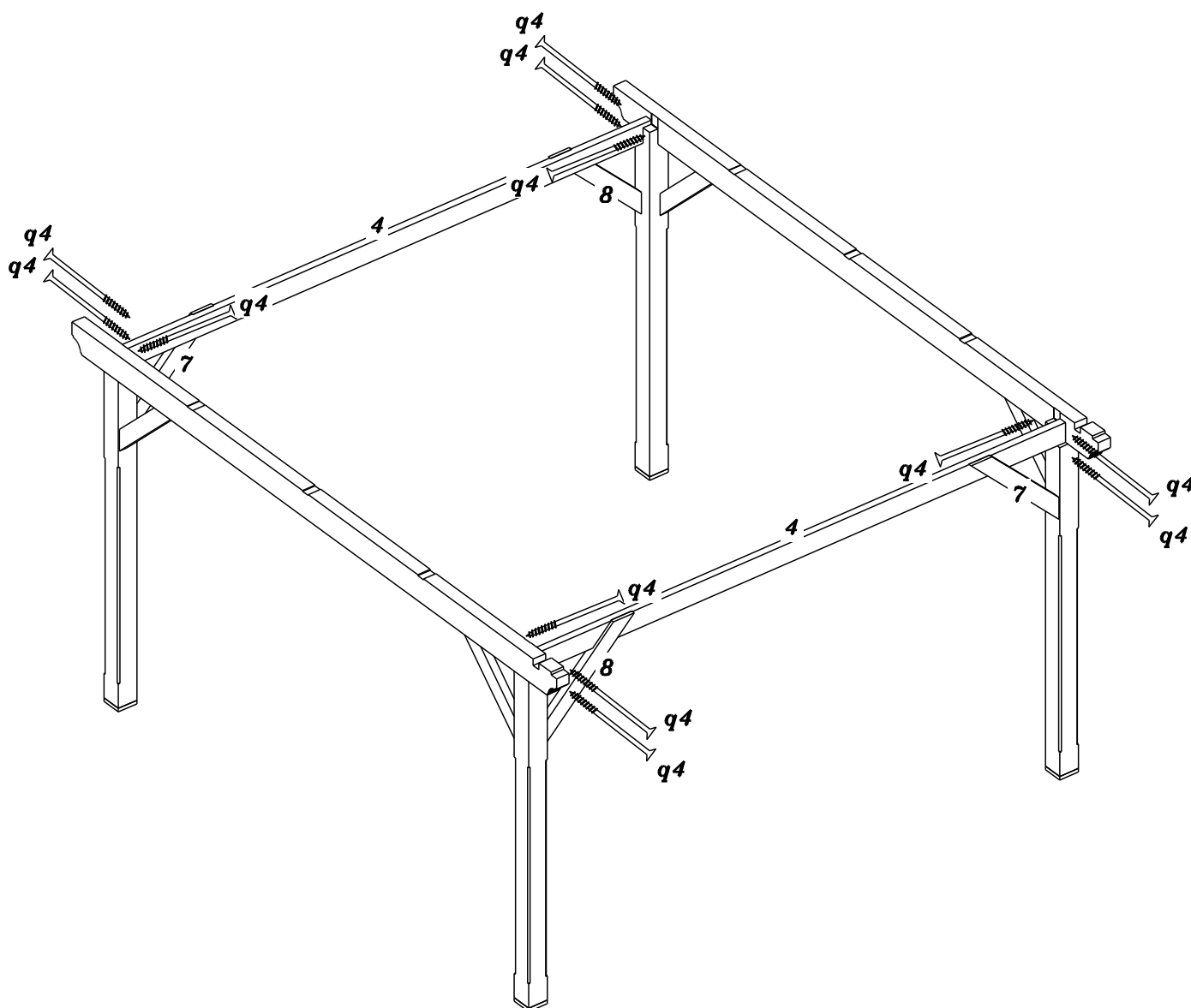

Réf.	Qté.	Dimensions (mm)		
4	2	45	120	3406
7	2	45	95	836
8	2	45	95	836
q4	12		ø 5	80

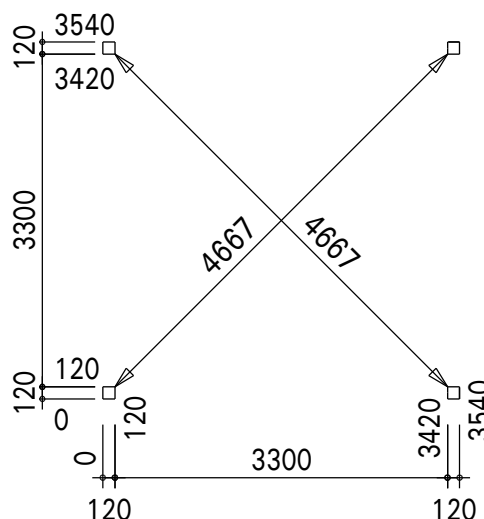
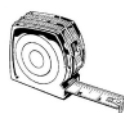

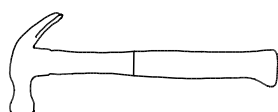
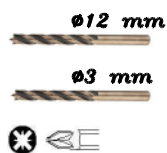
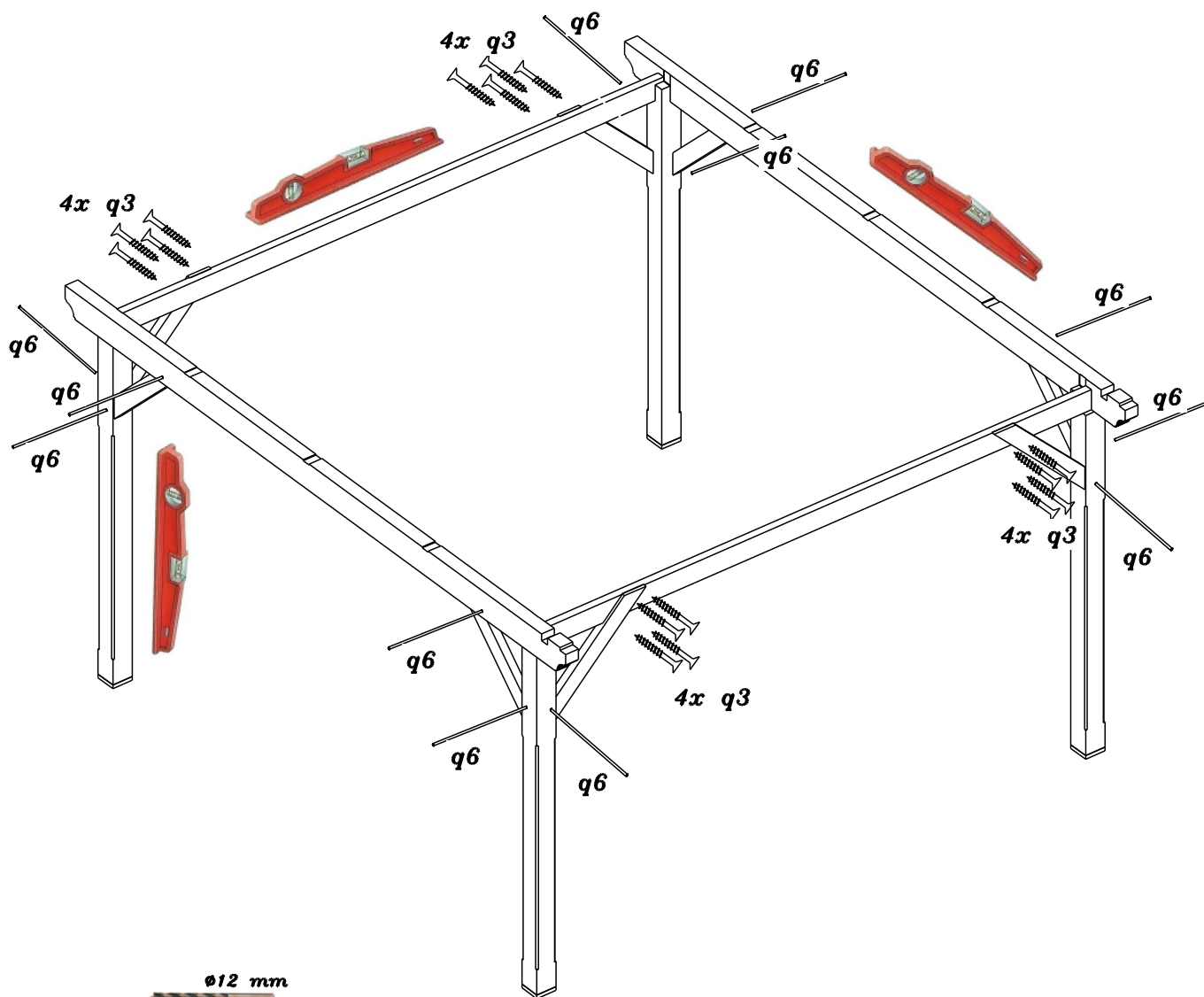

Réf.	Qté.	Dimensions (mm)		
q3	16		Ø 4	40
q6	12		Ø12	150

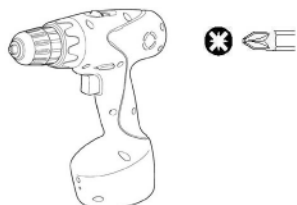
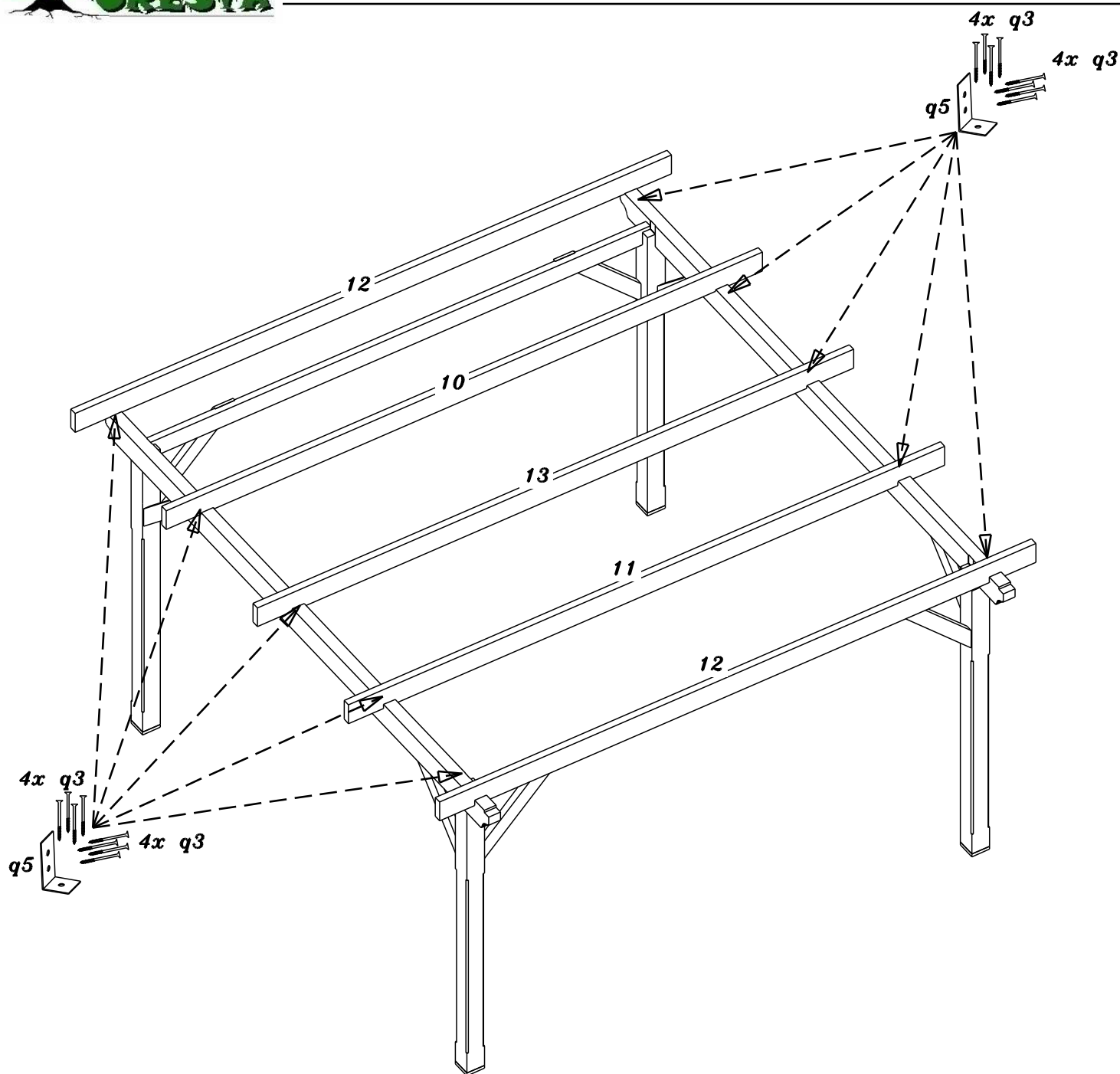

Réf.	Qté.	Dimensions (mm)		
10	1	45	145	4038
11	1	45	145	4038
12	2	45	145	4038
13	1	45	145	4038

Réf.	Qté.	Dimensions (mm)		
q3	80		ø 4	40
q5	10	50	90	50

Pour la pose de gouttière pensez aux différences de niveau des crochets afin d'obtenir une pente moyenne de 5 mm par mètre dans le sens de l'écoulement des eaux.

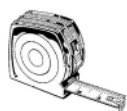
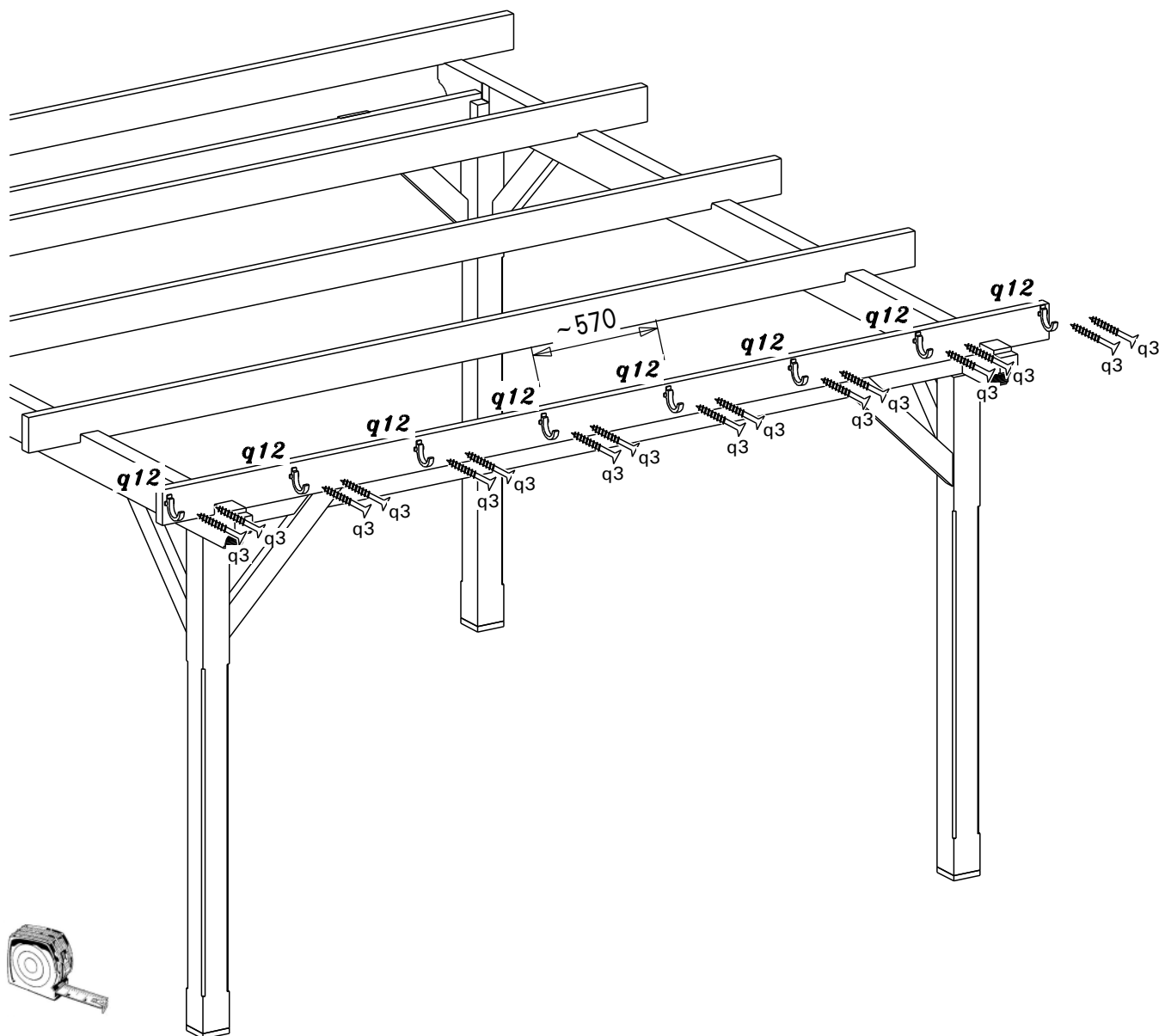

Réf.	Qté.	Dimensions (mm)		
q3	16		∅ 4	40
q12	8		70	

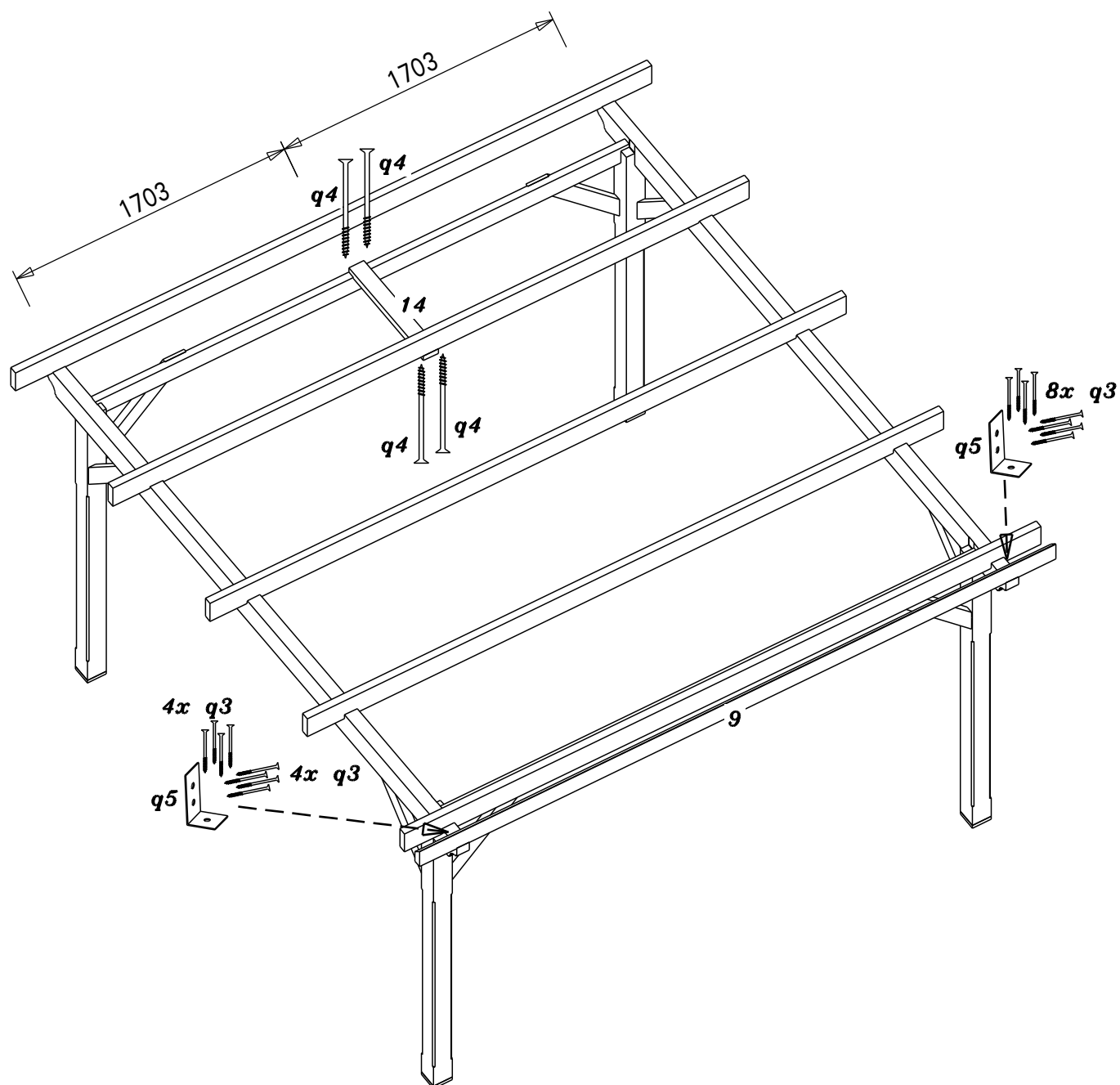

Réf.	Qté.	Dimensions (mm)		
9	1	45	120	4038
14	1	45	95	736

Réf.	Qté.	Dimensions (mm)		
q3	16	Ø 4	40	
q4	4	Ø 5	80	
q5	2	50	90	50

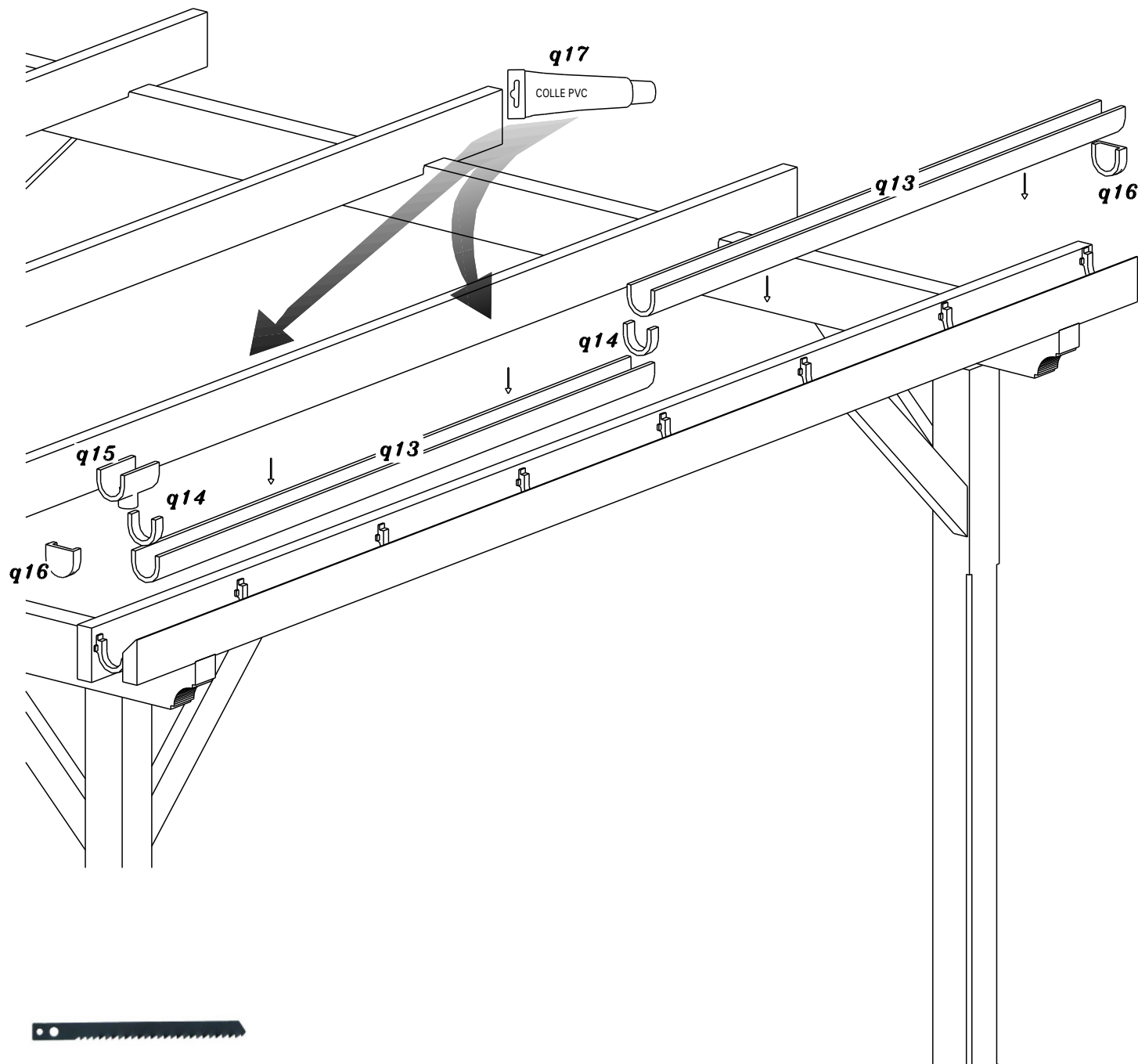

Réf.	Qté.	Dimensions (mm)		
q13	2		70	2000
q14	2		70	
q15	1		70	
q16	2		70	
q17	1			

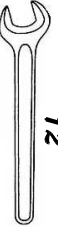
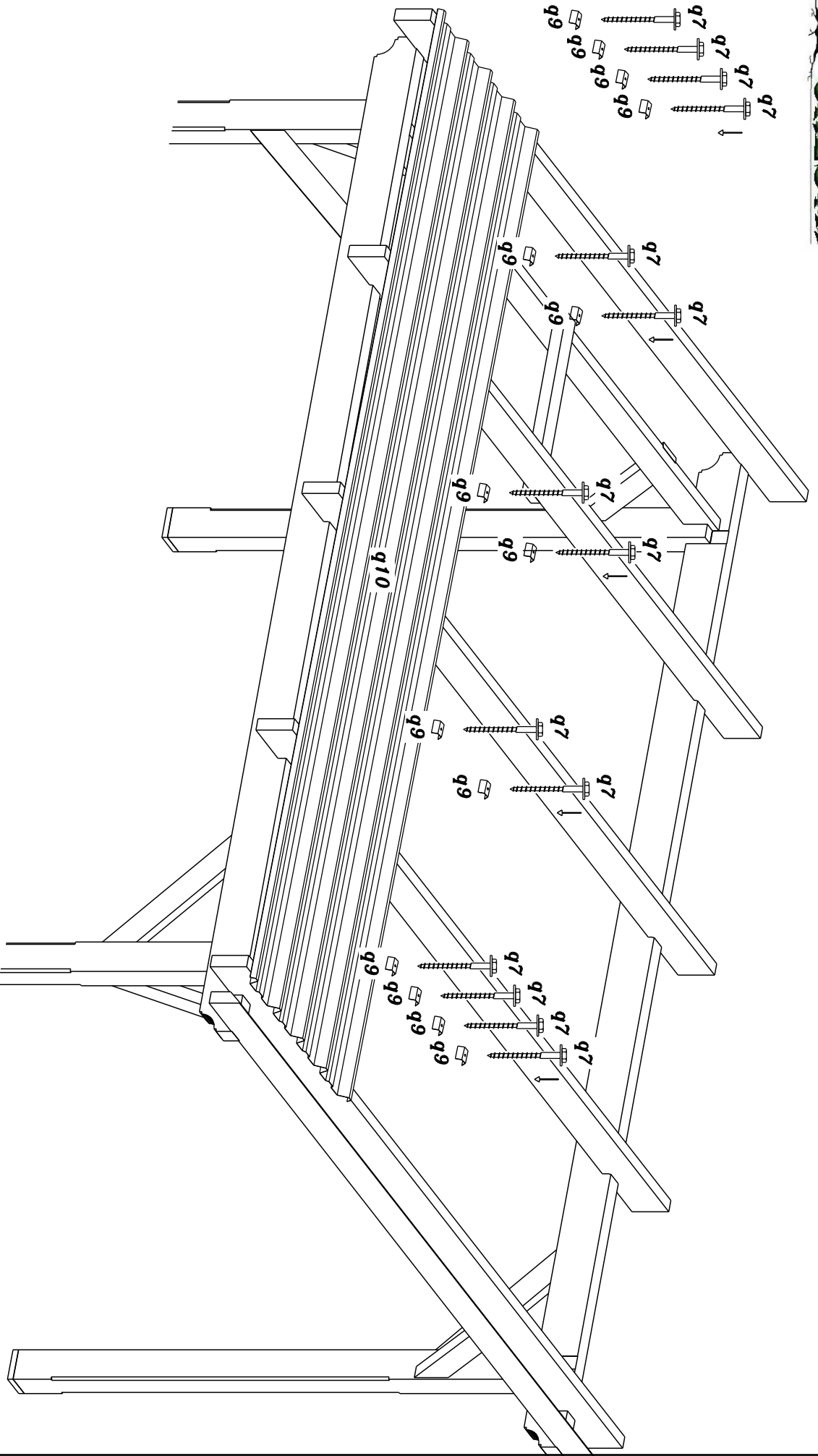

12

Réf.	Qté.	Dimensions (mm)		
q10	1	40	1000	3935

Réf.	Qté.	Dimensions (mm)		
q7	14		ø6,5	100
q9	14	38	12	40

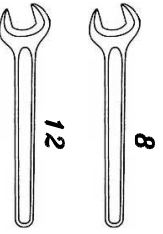
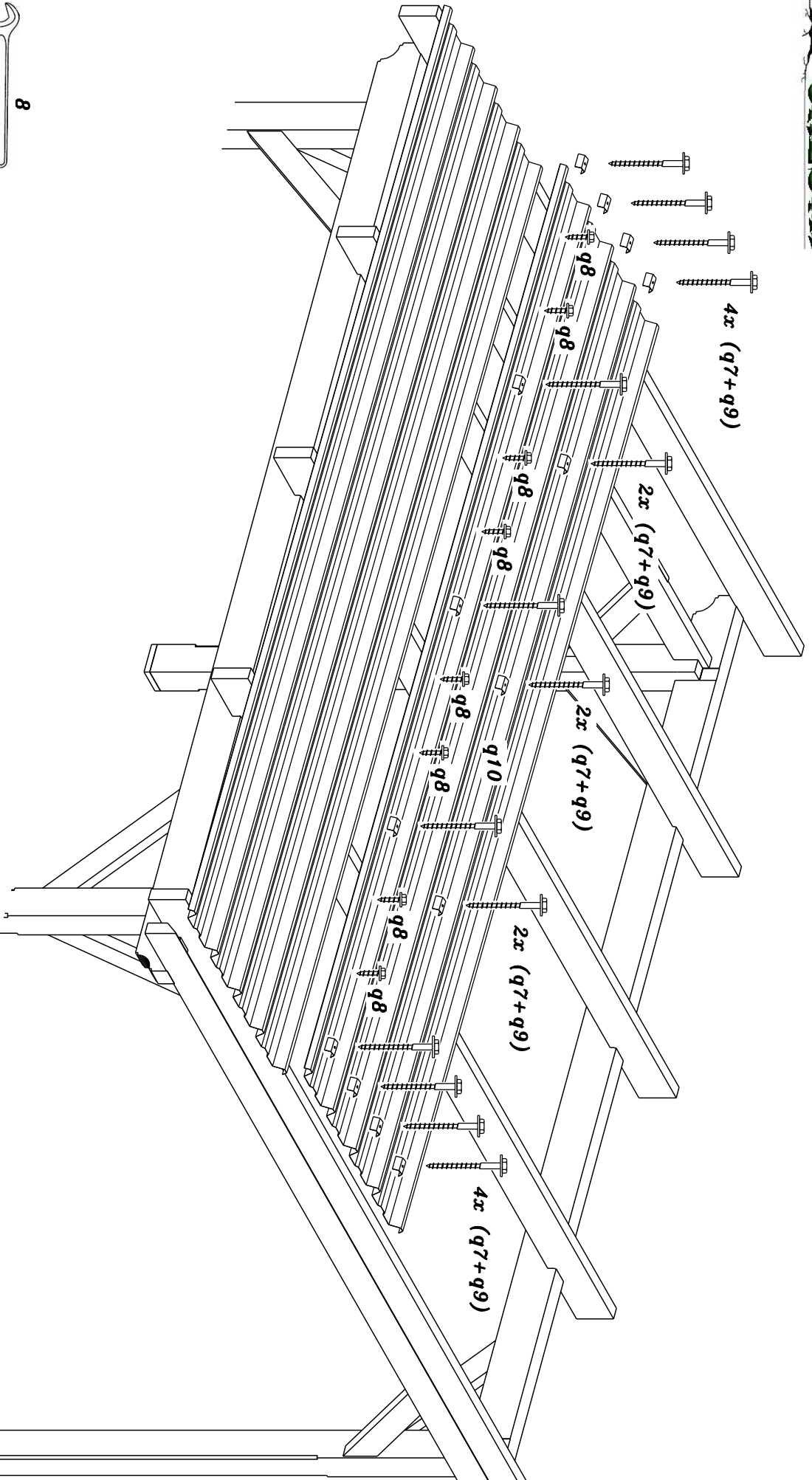

Réf.	Qté.	Dimensions (mm)		
q10	1	40	1000	3935

Réf.	Qté.	Dimensions (mm)		
q7	14		ø6,5	100
q8	8		ø4,8	20
q9	14	38	12	40

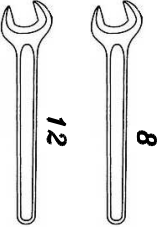
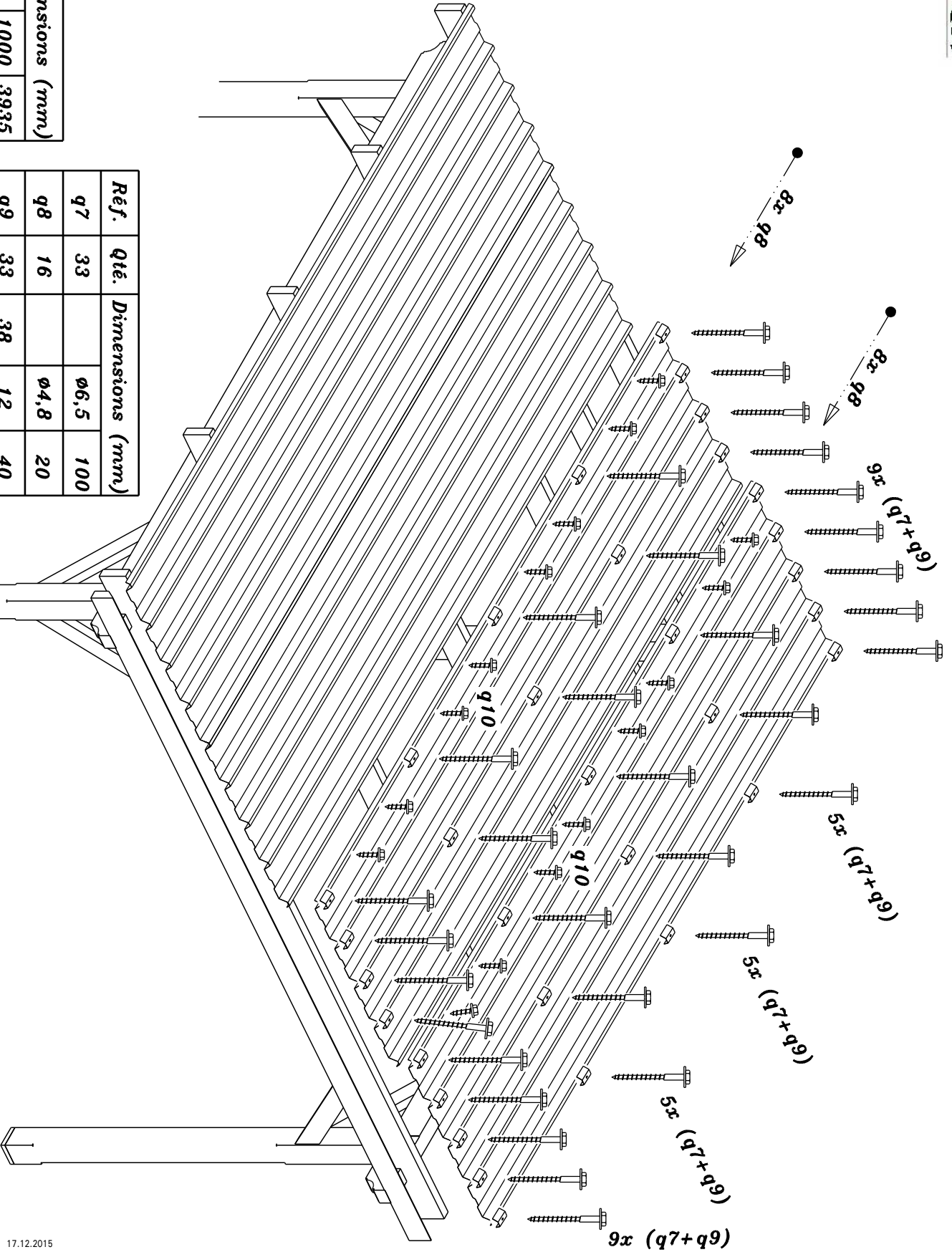

Réf.	Qté.	Dimensions (mm)		
q10	2	40	1000	3935

Réf.	Qté.	Dimensions (mm)		
q7	33		ø6,5	100
q8	16		ø4,8	20
q9	33	38	12	40

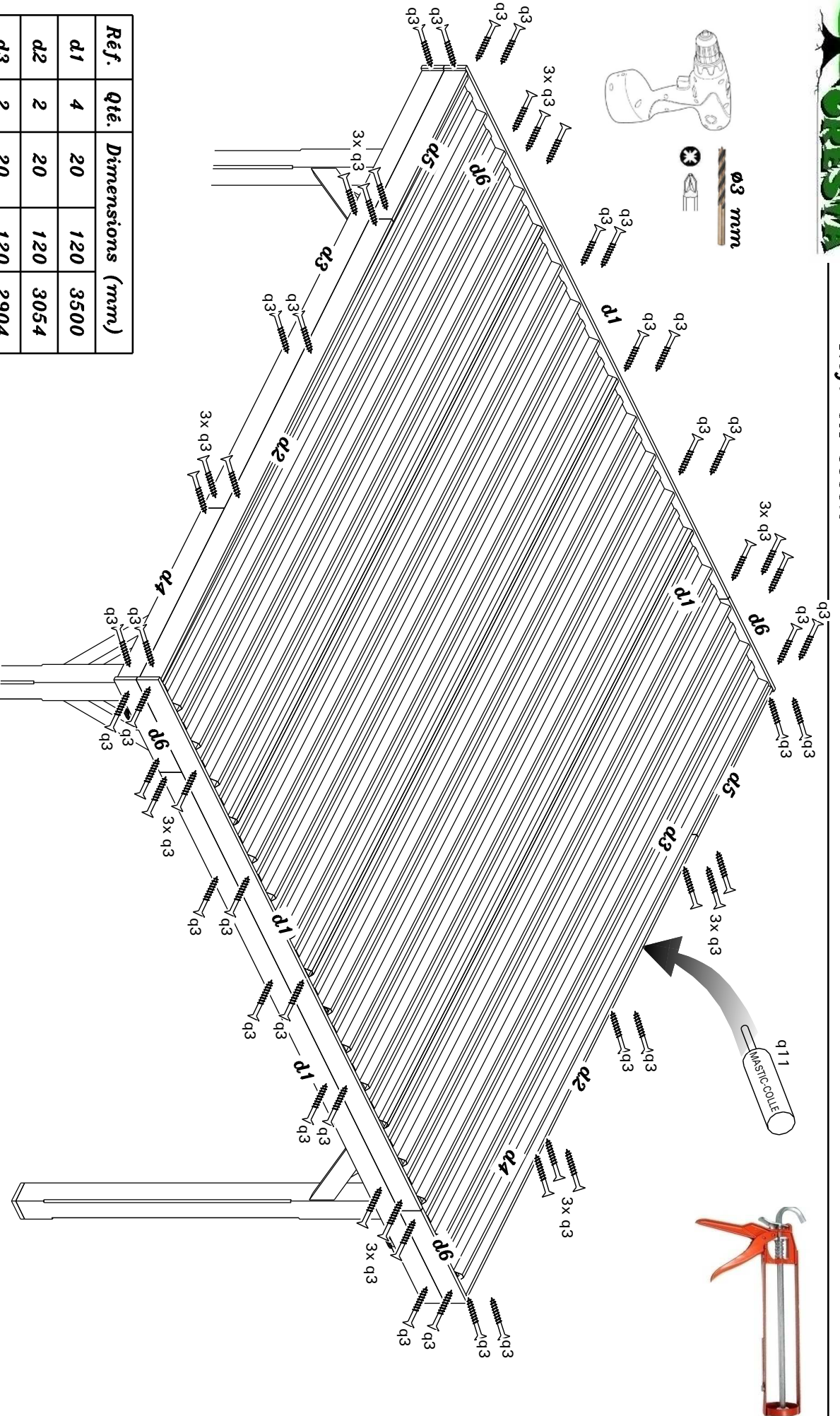

Réf.	Qté.	Dimensions (mm)	
d1	4	20	3500
d2	2	20	3054
d3	2	20	2904
d4	2	20	1135
d5	2	20	985
d6	4	20	610

Réf.	Qté.	Dimensions (mm)	
q3	56	∅ 4	40
q11	1		

Penser à prévenir votre assureur de l'existence de votre auvent pour garantie en cas de sinistre.

